

ROXY Exceed

User Manual

211.0010, Edition 8, 2023



Copyright ©2022, Antec Scientific, The Netherlands. Contents of this publication may not be reproduced in any form or by any means (including electronic storage and retrieval or translation into a foreign language) without prior agreement and written consent from the copyright of the owner. Antec reserves the right to make changes to the design and specifications of the instrument and this manual without prior notice.

DECADE Elite, DECADE Lite, ROXY, ALEXYS, ROXY Exceed, INTRO, FlexCell, ReactorCell, μ -PrepCell, ISAAC, HyREF, SenCell and SynthesisCell are trademarks of Antec Scientific. Whatman™ (word and device) and Whatman™ (word only) are trademarks of Whatman international Ltd. SOLVENT IFD™ and AQUEOUS IFD™ are trademarks of Arbor Technologies, Inc. Clarity®, DataApex® are trademarks of DataApex Ltd. Microsoft® and Windows™ are trademarks of Microsoft Corporation. Excel is a registered trademark of the Microsoft Corporation. Chromeleon™ is a trademark of ThermoFisher Scientific. All other trademarks are the property of their respective owners.

The software and the information provided herein is believed to be reliable. Antec shall not be liable for errors contained herein or for incidental or consequential damages in connection with the furnishing, performance, or use of software or this manual. All use of the software shall be entirely at the user's own risk.

CE Declaration of Conformity

We Antec Scientific, Alphen a/d Rijn, The Netherlands, declare that the product:

ROXY Exceed™ Potentiostat

type 211

to which this declaration relates, is in conformity with the following CE directives:

- 2014/35/EU** Low Voltage Directive (LVD)
- 2014/30/EU** Electromagnetic Compatibility Directive (EMC)
- 2015/863/EU** Directive on Restriction of the use of certain Hazardous Substances (RoHS)
- 2012/19/EU** Directive on Waste Electrical and Electronic Equipment (WEEE)

Product standards used for demonstration of compliance:

EN 61010-1:2010

Safety requirements for electrical equipment for measurement, control, and laboratory use; part 1: General Requirements.

EN 61010-2-010:2014

Safety requirements for electrical equipment for measurement, control, and laboratory use; part 2-010: Particular requirements for laboratory equipment for the heating of materials.

EN 61326-1:2013

Electrical equipment for measurement, control and laboratory use - EMC requirements; part 1: General Requirements (Class B equipment).

EN 55032:2015

Electromagnetic compatibility of multimedia equipment
Emission requirements (Class B equipment).



Only use manufacturer-supplied cable(s) to connect with other devices. Thoroughly connect shielding to common. Manufacturer will not accept any liability for damage, direct or indirect, caused by connecting this instrument to devices and with cables which do not meet relevant safety standards. All cables used should not exceed a length of 3 meters.

This DoC applies to above-listed product placed on the market after:

Date: January 31th, 2020

Dr. N.J. Reinhoud (managing Director)

UK CA Declaration of Conformity

We Antec Scientific, Alphen a/d Rijn, The Netherlands, declare that the product:

ROXY Exceed™ Potentiostat

type 211

to which this declaration relates, is in conformity with the following standards:

- 2014/35/EU** Low Voltage Directive (LVD)
- 2014/30/EU** Electromagnetic Compatibility Directive (EMC)
- 2015/863/EU** Directive on Restriction of the use of certain Hazardous Substances (RoHS)
- 2012/19/EU** Directive on Waste Electrical and Electronic Equipment (WEEE)

Product standards used for demonstration of compliance:

EN 61010-1:2010

Safety requirements for electrical equipment for measurement, control, and laboratory use; part 1: General Requirements.

EN 61010-2-010:2014

Safety requirements for electrical equipment for measurement, control, and laboratory use; part 2-010: Particular requirements for laboratory equipment for the heating of materials.

EN 61326-1:2013

Electrical equipment for measurement, control and laboratory use - EMC requirements; part 1: General Requirements (Class B equipment).

EN 55032:2015

Electromagnetic compatibility of multimedia equipment
Emission requirements (Class B equipment).

 **Only use manufacturer-supplied cable(s) to connect with other devices. Thoroughly connect shielding to common. Manufacturer will not accept any liability for damage, direct or indirect, caused by connecting this instrument to devices and with cables which do not meet relevant safety standards. All cables used should not exceed a length of 3 meters.**

This DoC applies to above-listed product placed on the market after:

Date: June 26th, 2023

Dr. N.J. Reinhoud (managing Director)



Table of contents

Symbols 8
Intended use 10
WEEE directive 11
ROHS directive 11
Safety instructions 12

Introduction 16

Instrument description 17

Installation 20

Storage requirements 20
Site Preparation Requirements 20
Unpacking 25
Mains connection 27
PC connection 27
Software 31
LC connections 32

Maintenance & Shutdown 36

Maintenance 36
Shutting down the system 38

ROXY Exceed control 40

Introduction 40
Overview of ROXY Exceed screens 41
Parameters 46
Dialogue Elite 51
Chromeleon CDS 53

Operation modes & Parameters 54

Three- or two electrode configuration 54
Internal organization 56
Dual flow cell control 56
Parameters 58
Filter 61

Measurement modes 65

DC mode 65
Pulse mode 66
Pulse mode -2 68
Scan mode 69

Optimization of working potential 70

Hydrodynamic and scanning voltammogram 72

Specifications ROXY Exceed 86

Rear panel I/O 94

USB B connector 95
LAN connector 95
VALVE connector 95
ANALOG DATA connector 101

Digital I/O connector 104
Chassis grounding stud 111

Troubleshooting 114

Instrument errors 114
Dummy cell test 116

Potentiostat accessories 125

Index 128

Symbols

The following symbols might be used in this guide or may be found on the instrument:



This sign warns about the risk of electric shock. It calls attention to a procedure or practice which, if not adhered to, could result in loss of life by electrocution. Do not proceed beyond a danger sign until the indicated conditions are fully understood and met.



The warning sign denotes a hazard. It calls attention to a procedure or practice which, if not adhered to, could result in severe injury, loss of life or damage or destruction of parts or all of the equipment. Do not proceed beyond a warning sign until the indicated conditions are fully understood and met.



The caution sign denotes a hazard. It calls attention to a procedure or practice which, if not adhered to, could result in damage or destruction of parts or all of the equipment and/or erratic results. Do not proceed beyond a cautions sign until the indicated conditions are fully understood and met.



The biohazard sign draws attention to the fact that use of biological materials, viral samples may carry a significant health risk.



The toxic hazard sign draws attention to the fact that use of toxic solvents or samples may carry a significant health risk.



The hot surface sign calls attention to parts in the instrument that must not be touched, as they may cause burns.



This symbol indicates electrostatic discharge (ESD hazard), damages to system, device, or components can occur if not properly grounded.



This symbol indicates that the waste of electrical and electronic equipment must not be disposed as unsorted municipal waste and must be collected separately. Please contact the manufacturer or authorized representative of the manufacturer for information concerning the decommissioning of equipment.



A device or system marked with CE fulfills the product specific requirements described in the European directives. This is confirmed in a Declaration of Conformity.



Certification marking for Canada and the USA issued by MET labs, a Nationally Recognized Testing Laboratory (NRTL). The certified device complies to the relevant UL and CSA safety (61010-1) standards.



Frame or chassis ground terminal, which can be used as to make additional external grounding connection.



The note sign signals additional information. It provides advice or a suggestion that may support you in using the equipment.



The attention sign signals relevant information. Read this information.

Intended use

The ROXY potentiostat in combination with flow-through reactor (μ -PrepCell or ReactorCell) or batch reactor cells (SynthesisCell) is used for controlled REDOX reactions up-front Mass Spectrometric detection. It can be used in a wide range of applications, for example:

- Fast synthesis of metabolites (μ -preparative)
- Rapid risk assessments of drug-protein binding
- Signal enhancement in MS
- Electrochemical cleavage of proteins/peptides
- Reduction of disulfide bonds in proteins/peptides
- Oxidative stress/damage of proteins, DNA, lipids, etc.



For research purposes only. While clinical applications may be shown, this instrument is not tested by the manufacturer to comply with the In Vitro Diagnostics Directive.

This instrument is not specifically designed and intended for quantification of analytes in LC, for that purpose the DECADE Elite/Lite electrochemical detector is available. Operation of the ROXY potentiostat in combination with a flow cell can involve the use of hazardous materials including corrosive fluids and flammable liquids. The instrumentation should only be operated by users with the following expertise:

- Completed degree as chemical laboratory technician or comparable vocational training
- Fundamental knowledge of liquid chromatography equipment and mass spectrometry
- Participation in an installation of the system performed by the manufacturer or a company authorized by the manufacturer and suitable training on the system and chromatography software.
- Knowledge and experience in the safe handling of toxic and corrosive chemicals and knowledge of the application of fire prevention measures prescribed for laboratories.

Information on safety practices is provided with your instrument and operation manuals. Before using your instrument or accessories, you must thoroughly read these safety practices. This manual is written for laboratory technicians / scientists skilled in the art.



Unskilled, improper, or careless use of this instrument can create fire hazards, or other hazards which can cause death, serious injury to personnel, or severe damage to equipment and property. Observe all relevant safety practices at all times. Only use the device for applications that fall within the scope of the specified intended use. Else the protective and safety equipment of the device could fail.

WEEE directive

All equipment of Antec Scientific which are subjected to the WEEE directive shipped after August 13, 2005 are compliant with the WEEE marking requirements. Such products are labelled with the “crossed out wheelie”, depicted on the left site.



The symbol on the product indicates that the product must not be disposed as unsorted municipality waste.

Collection & recycling information

Please ship the instrument back to the manufacturer (Antec Scientific, the Netherlands) at the end-of-life time of the product. The manufacturer will take care of the proper disposal and recycling of the instrument at its facilities. For more info: info@antecscientific.com.

Shipping address for the end-of-life products:

Antec Scientific, Hoorn 131, 2404 HH Alphen a/d Rijn, The Netherlands

In case of questions, or if further information is required about the collection & recycling procedure, please contact your local distributor.

ROHS directive



The ROXY Exceed is ROHS compliant and in conformity with Directive EU 2015/863 Restricted use of Hazardous Substances in electrical and electronic Equipment (ROHS).



Antec Scientific is an ISO 9001:2015 certified company.

Safety instructions

Adhere to the following standard quality control procedures and the following equipment guidelines when using the ROXY Exceed potentiostat. The following safety practices are intended to ensure safe operation of the instrument.

Working environment & safety



The intended use of the ROXY potentiostat is to perform controlled REDOX reactions of target compounds (in a suitable liquid electrolyte medium) up-front Mass Spectrometric detection in a GLP-approved environment under the specified environmental conditions. Operators using the system should have the appropriate education and an extensive understanding of GLP rules and be skilled in the art. Use this system **ONLY** for the intended use. Use of the system for any other purpose will cause unsafe situations.

System Operation



To assure optimal performance keep of the potentiostat we recommend that the instrument is checked regularly and maintenance procedures are carried out. Preventive maintenance contracts are available for that Purpose. Please contact your local dealer or the nearest sales office for more information.

Electrical safety



The removal of protective panels on the instrument can result in exposure to potentially dangerous voltages. Therefore, disconnect the instrument from all power sources before disassembly.

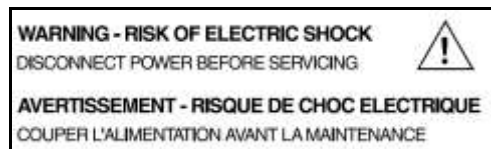

Untrained personnel should not open the instrument, **this may only be done by authorized service engineers**. Replace or repair faulty insulation on power cords immediately after discovery of the fault. Check that the actual power voltage is the same as the voltage for which the instruments are wired. Make sure power cords are connected to correct voltage



sources: grounded AC power source, line voltage 100 – 240 VAC. The instrument should be connected to a protective earth via a ground socket. The ROXY Exceed must only be used with appliances and power sources with proper protective grounding to prevent damage through build-up of static electricity. The power source should exhibit minimal power transients and fluctuations. If necessary connect to a filtered mains socket.

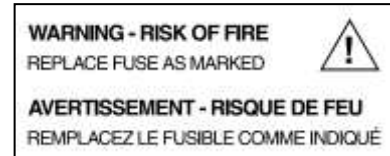
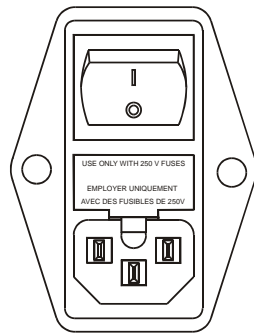

V ~ 100-240V FUSE RATING
50 / 60Hz 
260VA 2.5 AT / 250V

Replace blown fuses with fuses of proper type and rating as indicated on the rear panel and as listed in the list of accessories and spares (appendix D). The fuse holder is integrated in the mains connector. Ensure that the instrument is never put in operation with fuses of a different type. This could cause fire.

Only use manufacturer-supplied I/O cable(s) to connect with other devices.

Thoroughly connect shielding to common. Manufacturer will not accept any liability for damage, direct or indirect, caused by connecting this instrument to devices and with cables which do not meet relevant safety standards. Place the potentiostat on a flat and smooth surface. Do not block the ventilation holes located at the bottom and lower rear panel of the potentiostat. Blocking these holes may impair the cooling capability of the power supply.

Solvents



The solvents used may be flammable, toxic or corrosive. The room in which the system is installed should be well ventilated to prevent that solvent vapors cause poisoning or ignite and cause a fire. Use of open fire in the vicinity of this system must be strictly prohibited. Do not install the system in the same room with any other equipment that emits or could potentially emit sparks. Provide protective equipment near the instrument, when

solvent gets into the eyes or on the skin, it must be flushed away immediately. Provide equipment, such eye wash stations and safety showers, as close to system as possible. Use proper eye and skin protection when working with solvents. Additional safety requirements or protection may be necessary depending on the chemicals used in combination with this equipment. Make sure that you understand the hazards associated with the chemicals used and take appropriate measures with regards to safety and protection. Sample containers (vials) should be sealed to minimize any risks related to solvent vapor.

Biological Hazard



When you analyze biological fluids you need possible precautions and treat all specimens as potentially infectious. Always wear protective And gloves when handling toxic or biologically infectious samples to prevent bio hazards or hazards while working with the ROXY Exceed. **If applicable the instrument must be decontaminated before decommissioning or shipment of the instrument for repair to Antec or its representatives.** When shipped to Antec every instrument has to be accompanied with a decontamination form which should be completely filled in and signed by the customer. Without this decontamination form the instrument will not be processed by Antec (either repaired or disposed).

Waste disposal



Perform periodic leak checks on LC tubing and connections. Do not close or block the drain in the oven compartment. Do not allow flammable and/or toxic solvents to accumulate. Follow a regulated, approved waste Disposal program. Never dispose of flammable and/ toxic solvents through the municipal sewage system.



Using the ROXY Exceed in other ways than indicated in the manual or defined by good laboratory practice may result in erratic or unsafe operation.

CHAPTER 1

Introduction

Congratulations on your purchase of the ROXY Potentiostat. With more than 25 years of experience in Electrochemistry (EC), Antec introduces a new, dedicated Potentiostat for on-line EC/MS and EC/LC/MS. The ROXY Potentiostat generates metabolites of drugs or xenobiotics, similar to those generated during in vivo metabolic processes, in a significantly shorter time span (seconds vs. days or weeks) without any interfering components (no isolation steps required). The ROXY Potentiostat is based on state-of-the-art electronics with a large voltage range of ± 4.9 V, and a push button electrode regeneration program. Operational parameters and external equipment can be controlled through programmable timed events. Consequently, the generation of specific oxidation products, e.g., metabolites, cleavage products, etc., and supreme control of any conceivable Redox reaction is assured.



This manual covers the installation, set-up and operation of the ROXY Exceed only. Detailed operation instructions for other peripheral LC equipment and parts such as flow cells, Mass spectrometers, pumps, auto samplers, valves, column heaters etc. are given in the manuals accompanying those accessories.

Instrument description

ROXY Exceed – Front side



#	Description	#	Description
1	Instrument housing	7	'+' and '-' value keys
2	LC tubing inlet/outlet	8	Cursor keys
3	Instrument door panel	9	Door handle (for opening door)
4	4 x 40 Ch LCD display		
5	Function keys		
6	<Enter> key		

ROXY Exceed – Back side

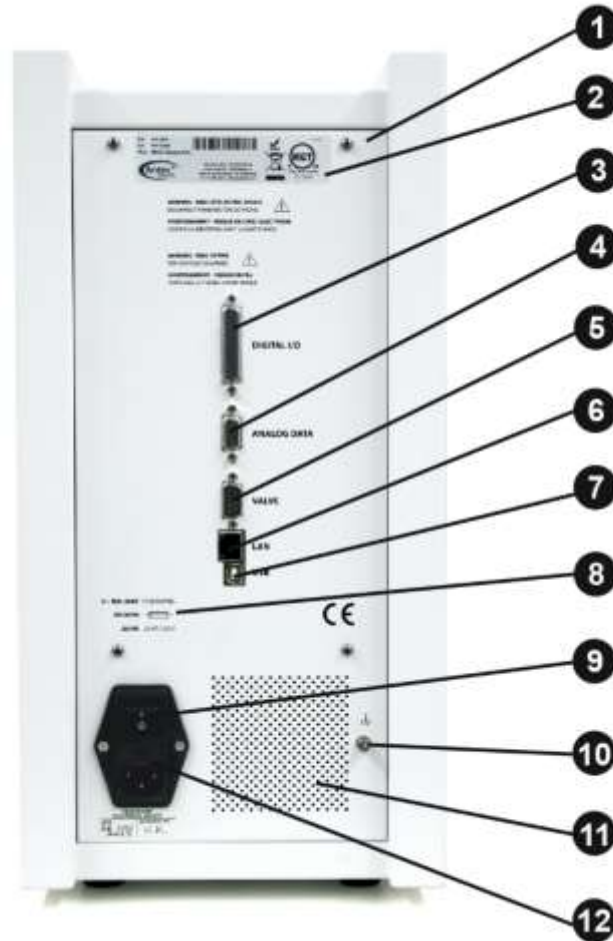

#	Description	#	Description
1	Instrument rear panel	7	USB connector (USB B)
2	Type label (pn, sn etc.)	8	Fuse & power rating
3	Digital I/O connector (25-pins sub-D fem)	9	Mains switch/inlet
4	Analog data (9-pins sub-D fem)	10	Grounding stud
5	Valve connector (9-pins sub-D male)	11	Fuse compartment
6	LAN connector (RJ45 jack)	12	Ventilation holes

ROXY Exceed – Oven compartment

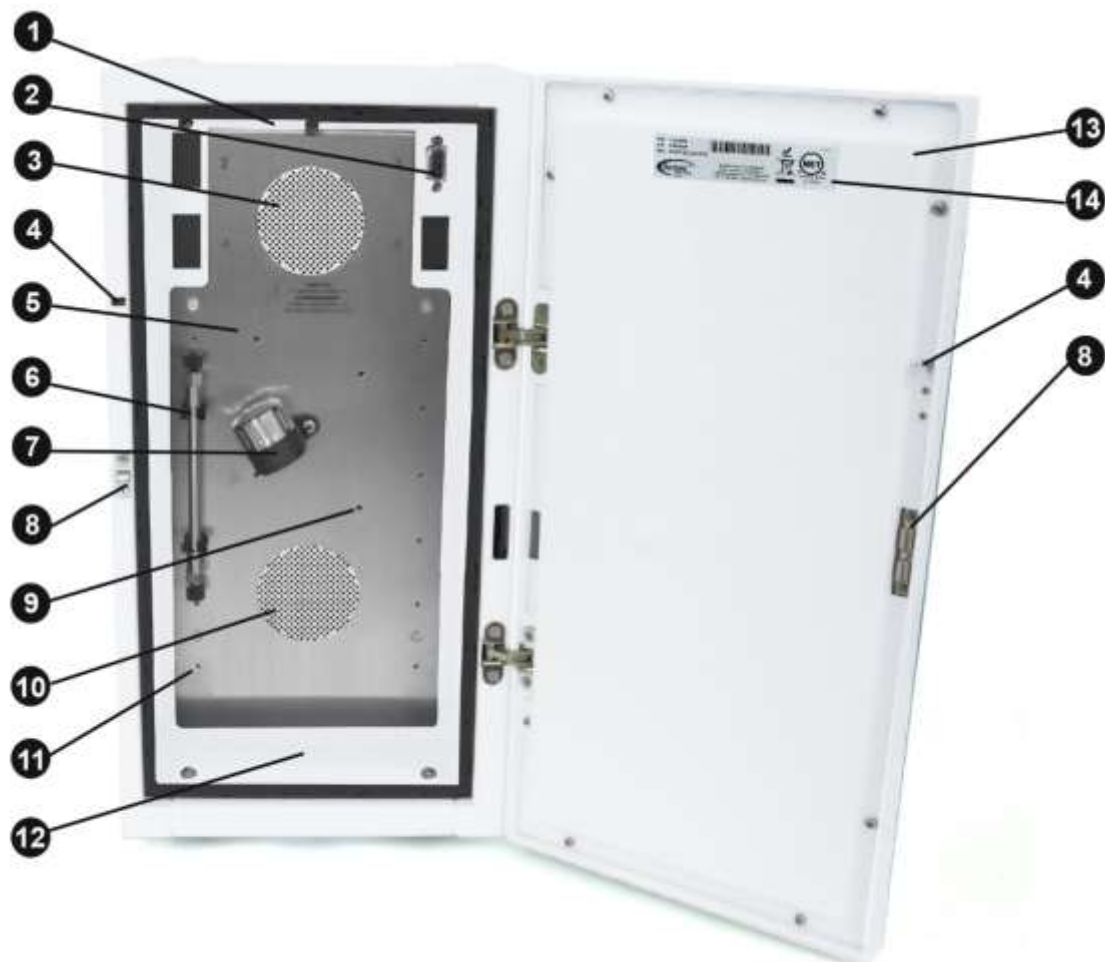

#	Description	#	Description
1	Cell cabinet	8	Door lock
2*	Cell connector (9-pins sub-D fem)	9	Mounting hole for cell clamp (M4)
3	Top fan heater (intake)	10	Bottom fan heater (exhaust)
4	Door sensor	11	Mounting hole for column clamp (M3)
5	Mounting plate (for cells & columns)	12	Fuse compartment
6	Column clamp	13	Door panel, rear
7	Flow cell clamp (for SenCell) [#]	14	Type label

[#]) Note the shown cell (SenCell) is just an example, for ROXY other type of flow-through reactor cells are used.

^{*}) The standard ROXY Exceed potentiostat has 1 reactor cell connector, the DCC has two cell connectors (DCC is the maximum cell configuration for the Exceed).

CHAPTER 2

Installation

Storage requirements

The ROXY potentiostat is shipped in one box to your facility with the following dimensions:

Equipment	Dimensions storage box
ROXY potentiostat	59 (D) x 41 (W) x 56 (H) cm (23.2 x 16.1 x 22.0 in)

Make sure to have sufficient space to store the packed instrument under the following storage conditions:

Parameter	Requirement
Storage temperature	-10 – 50 °C (14 – 122 °F)
Storage humidity	20 – 80%, non-condensing

Site Preparation Requirements



It is evident that (for as far it is not specified in this document) the installation site must comply with all applicable local laws and regulations with regard to electrical and mechanical installations, building safety, and use of potentially hazardous materials/chemical and disposal thereof, etc.

For a successful onsite installation of the instrument, please arrange the following requirements at your location in advance:

Personal Computer

In case the instrument is used via remote control by PC software (Dialogue Elite or Thermo Chromeleon CDS) or a firmware (FW) update needs to be performed a desktop computer is required with the following requirements:

- Free LAN port (onboard, PCI, PCI express or PCI-X)
- Free USB port (required for FW updates)
- Microsoft Windows 7 Operating System or higher*

*) An US or European Microsoft® Windows™ version is recommended. The Windows operating system should be updated with the latest Service Packs.

Further information about software packages and requirements please visit the Antec website www.antecscientific.com.



Installing software requires a computer with administrator access. Make sure that the PC and its USB ports is authorized/able to install third-party software. Inform your IT department well in advance to arrange authorization to avoid unnecessary delays during the installation.



For uninterrupted operation of a ROXY EC system and control software Antec advises to turn off:

- Screensavers
- (USB, LAN) hibernate mode
- Auto hard disk shut down (energy saving)
- Automatic Windows updates
- Avoid exhaustive scanning by virus scanners*

*) In your antivirus SW, turn off the option "Check Files at Change" for the relevant Dialogue Elite data storage directory.

The PC for control and data-acquisition of the system should be placed in the vicinity of the ROXY potentiostat, within a distance of max 2.5 meter.

Laboratory requirements

Your instrument is intended for indoor use only in an industrial or commercial environment (EN55011 group 1 class B ISM equipment). It is suitable for the following categories: Installation category II, Pollution degree 2, equipment class I.

Table I. Environmental specifications

Parameter	Requirement
Operating temperature	10 – 35 °C (50 – 104°F)
Maximum Altitude	2000 meter (7500 ft)
Operating humidity	20 – 80%, non-condensing



For optimum analytical performance it is recommended that the ambient temperature of the laboratory be between 20-25 °C and be held constant to within ± 2 °C throughout the entire working day. Note: that for optimal temperature stability of the cell cabinet the oven temperature should be set to a temperature at least 7 degrees higher as ambient temperature.



Do not place the system next to heating or cooling pipes or expose the instrument to direct sun light or expose it to air drafts (AC system / open windows).

Requirements for the laboratory bench on which the instrument will be installed:

- Stable, clean, flat and smooth surface.
- Enough mechanical strength to hold at least the weight of the potentiostat. A ROXY potentiostat SCC without cell weights 14.4 kg (31.7 lbs). A full-dressed potentiostat with flow cells and peripherals columns and valves may weigh up to 20 kg or more.
- A potentiostat has the following dimensions 44 (D) x 22 (W) x 43 (H) cm = 17.3" (D) x 8.7" (W) x 16.9" (H). Take into account that additional space is necessary on all sides to prevent obstruction of ventilation holes and allow sufficient heat dissipation. Keep at least 15 cm free at the back. Keep at least 5 cm distance, if there is another device on one side. Keep at least 10 cm distance, if there are devices on both sides.
- In the case the ROXY Exceed is coupled online to MS, the potentiostat and flow cell should preferably be positioned as close as possible to the inlet of the ionization source of the MS. In the case the ESI interface is not grounded, a grounding connection is required in the fluid lines between the flow cell and ESI inlet, for this purpose a grounding kit is available (pn 210.0070), see the accessory section in this manual.



Tip: Installation of the ROXY potentiostat + PC on a suitable movable laboratory cart/table has multiple advantages:

- Easy access to all sides of the instrumentation
- System can be easily manoeuvred next to the (ESI inlet) MS
- Flexibility with respect to use of both ROXY potentiostat and MS.



Electrical and power requirements

The customer is responsible for providing appropriate electrical power and power outlets in the laboratory.

1. The installation of electrical supplies and fixtures in the laboratory must be in compliance with all local regulations and safety standards.
2. The power source should exhibit minimal power transients and fluctuations. The AC mains supply voltage source should not fluctuate more than +/- 10% from the nominal voltage. If your mains voltage is unstable (>10% of nominal voltage use an Uninterruptable Power Supply (UPS) The mains supply must include a correctly installed protective earth conductor.



To protect against power transients (voltage spikes and power surges) it is advised to connect the equipment over an electrical surge protector.

3. The Roxy potentiostat is equipped with an universal AC/DC switched-mode power adapter rated for 100–240 V AC and 50/60 Hz. Every potentiostat is delivered with a set of 2 power cords for the following regions:
 - EUR (CEE7/7 plug to IEC60320 C13 plug)
 - US (NEMA 5-15 plug to IEC60320 C13 plug)



For regions with deviating mains plugs/sockets like (for example UK, Switzerland, Brazil etc.) make sure to have the appropriate power cords available on-site at the date of installation. Make sure these power cables are properly grounded and meet the relevant safety standards which apply in your country. In case of questions contact your local distributor.

4. The maximum power consumption of the ROXY potentiostat on full power) is < 200 Watt. The typical power consumption is < 50 Watt.
5. Connect the potentiostat to a grounded AC wall socket with a line voltage of 100 – 240 VAC (as specified in the sections above) using the supplied power cables. The instrument should be connected to a protective earth via the socket. Make sure the detector is placed in such a way that the mains power connection can be reached easily to disconnect it from the mains power by removing the power cable.



Only use manufacturer-supplied cable(s) to connect with other devices. Thoroughly connect shielding to common. Manufacturer will not accept any liability for damage, direct or indirect, caused by connecting this instrument to devices and with cables which do not meet relevant safety standards.

Chemicals

Mobile phase and flush/storage solutions must be clean as it is in direct contact with the working electrode of the electrochemical reactor cell. High purity chemicals including water is a prerequisite. So all chemicals should be electrochemically clean, HPLC grade or better. For water used for the preparation of mobile phases a water purification apparatus is advised which is able to supply high purity deionized water with resistivity of >18 MOhm.cm and low TOC level (<10 ppb).

Unpacking

Inspect the *transport box* for possible damage as it arrives. Immediately inform the transport company in case of damage, otherwise she may not accept any responsibility. Keep the transport box as it is designed for optimum protection during transport and it may be needed again. Carefully unpack the system and inspect it for completeness and for possible damage. Contact your supplier in case of damage or if not all marked items on the checklist are included. Prior to shipment, your potentiostat has been thoroughly inspected and tested to meet the highest possible demands. The results of all tests are included.

See check list below for reference:

- | | | |
|-----|---|-----------------------|
| (1) | Delivery is in accordance with order | <input type="radio"/> |
| (2) | Delivery is undamaged | <input type="radio"/> |
| (3) | All items on checklist(s) are included | <input type="radio"/> |
| (4) | Certificates of performance are included: | |
| | - potentiostat | <input type="radio"/> |
| | - flow cell(s)* | <input type="radio"/> |
| (5) | User manual(s) is (are) included on USB stick | <input type="radio"/> |

*) Note that flow cells are not part of the ROXY Exceed potentiostat and have to be ordered separately.

To unpack the potentiostat, lift it from its box by both hands (Fig. 1). **Never lift the potentiostat at its front door**, but at its sides.

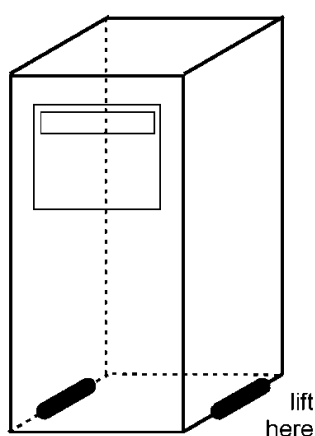

Fig. 1. Lift instructions ROXY Exceed.

With both hands under the instrument lift the potentiostat to its operation location. Install the potentiostat in an area which meets the environmental conditions.



Fig. 2. Location of ventilation holes in the ROXY Exceed (bottom & rear).

Remove the protective tape from the ROXY Exceed LCD screen. Leave the instrument to adopt ambient temperature for at least half an hour in the place of installation.



Use the potentiostat indoors only. Place the potentiostat upright (on its instrument feet) on a stable, flat and smooth surface. Do not place the instrument in an area subject to excessive dust or shocks. Do not place it near a source of heat or in direct sun light, as this may influence the heating capabilities of the instrument. Make sure the potentiostat is placed in such a way that the mains power connection can be reached easily to disconnect it from the mains power by removing the Mains power cable. Do not block the ventilation holes at the back and bottom of the instrument (Fig. 2.). Blocking might impair the cooling capability of the power supply.

Do not place heavy object/instruments on top of the potentiostat. Objects can be placed on any side of the potentiostat; however, make sure these objects are placed at a distance of 5 cm from the potentiostat, in case that objects are placed at only one side of the instrument. and 10 cm from the instrument, if objects are placed on both sides of the instrument.

Mains connection

Check that fuses and voltage range on the rear side of the instrument match that for the power outlet to be used.



This device complies with the requirements of EN 55011 group 1 class A ISM equipment. In a domestic environment this product may cause radio interference in which case the user may be required to take adequate measures on his own expenses. Understanding power surges. Power surges, line spikes, and transient energy sources can impede instrument operation. Ensure that the instrument's electrical supply is adequately protected from these conditions and properly grounded. If necessary connect the instrument to a filtered mains inlet.



Power supply and protective earth: The system must be connected to a suitable mains power supply with a correctly installed protective earth conductor. Never use the system without a properly connected protective earth conductor.

Leave the instrument powered off until specifically mentioned in the procedure below.

PC connection

Follow the instructions in this paragraph when the instrument is used with PC control over LAN using the Dialogue Elite software. This section can be skipped if the instrument is used stand-alone (manual control using keyboard/display). To be able to communicate over LAN a computer is required with a free (PCI, PCI Express or PCI-X) LAN port.

The ROXY Exceed has a fixed IP address: 192.168.5.1, with subnet mask: 255.255.255.0. Gateway and DNS are not filled in.

The instrument is standard delivered with a special crossover LAN (UTP) cable (pn 250.0170) which is part of the ROXY Exceed accessory kit (pn 211.0200).



To insure stable and error-free communication only use the manufacturer-supplied LAN cable to connect the ROXY Exceed to the control PC. Create a small dedicated local area network to connect the ROXY Exceed to the PC. Do not connect the ROXY Exceed over a company Local Area Network. If needed a second network adapter with a different (unique) IP address range can be applied.

In the following section the procedure to connect the instrument to the PC using the crossover UTP cable is described. Configure the IP address of the PC LAN network card by executing the following steps (in this example the Windows 10 OS is used, in an older Windows OS the example screens may look different):

1. Right click on the Network icon in the bottom right of the Windows taskbar and open the menu 'Network & Internet settings'. Alternative: open Windows start menu, open Setting menu and open Network & Internet menu.



2. Open the menu 'Change adapter settings' on the right panel of the 'Network & Internet' window.

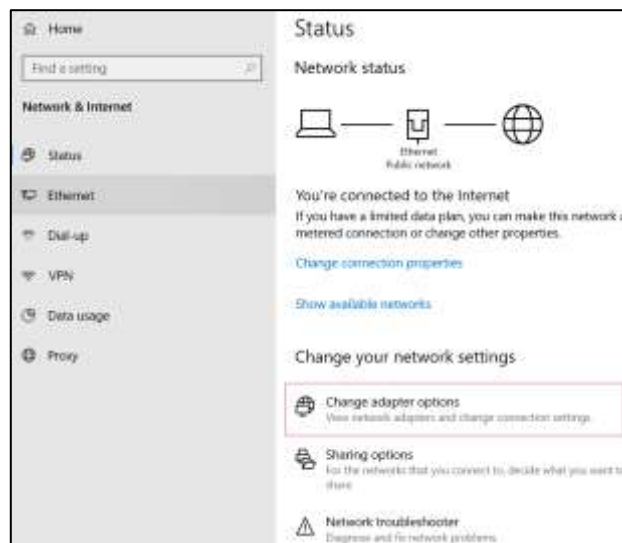

3. Right click on the Local Area Connection icon of the LAN card in your PC and click on properties to open the Network card setting.

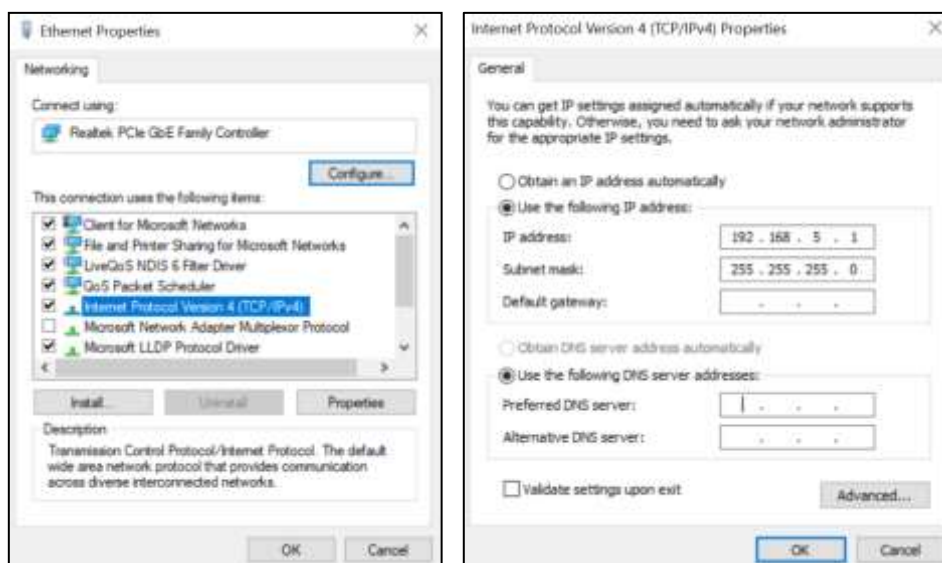
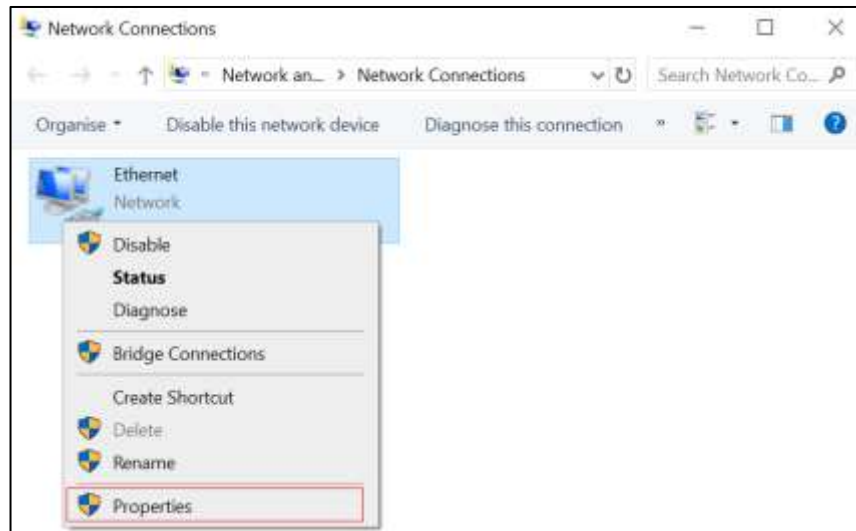

4. Open the menu 'Internet Protocol Version 4 (TCP/IPv4)' menu (double click).

5. Configure the network IP address and subnet mask as depicted in the screen dump below (IP 192.168.5.10, Subnet mask: 255.255.255.0). Gateway and DNS fields are not filled.

6. Close the menu(s) by clicking the 'OK' buttons. The network IP address of the LAN network card is now set up for communication with the ROXY Exceed.

7. Connect the crossover (UTP) cable to the RJ45 Jack of the LAN card of your PC (typically located on the backside of a desktop PC).

8. Connect the other end of the crossover LAN (UTP) cable to the LAN port on the rear panel of the ROXY Exceed as depicted on the photograph.

9. Switch on the ROXY Exceed. Set the potentiostat temperature to 35°C if an Operational Qualification (OQ) will be executed, or set it to the temperature at which your ROXY application is running. Allow the instrument to stabilize for at least half an hour before starting experimental work or performing an OQ. The OQ is described in a separate manual available on the Antec website.

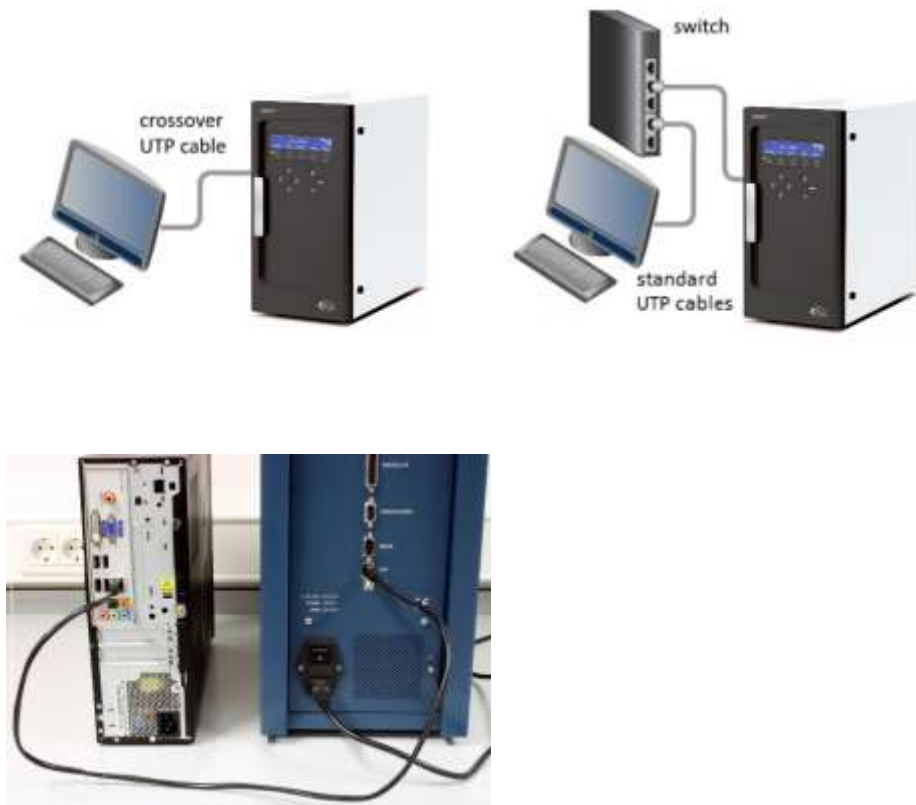

Fig. 3. Example of LAN connection between PC and ROXY Exceed. A direct connection requires the special crossover UTP cable delivered in the potentiostat ship kit. With a Ethernet switch any regular UTP cable can be used.

Software

The ROXY Exceed can be used remote in combination with PC control software. There are two software packages available for control of the ROXY Exceed electrochemical potentiostat:

- Dialogue Elite software from Antec Scientific, The Netherlands.
- Chromeleon CDS (version 7.2.9 and higher), ThermoFisher Scientific, USA*

*) Exceed control driver for Chromeleon planned to be released Q1 2020, besides a Chromeleon license (Instrument class 3 license) a separate software license is required for control of the Exceed under Chromeleon.

The Antec Dialogue Elite software is used for instrument control and Qualifications and is also required for the upload of new firmware (= embedded software controlling the ROXY Exceed electronics). In this section the installation of Dialogue Elite and configuration of the ROXY Exceed is shortly described. Note: this is by no means a replacement of the installation documentation available for the software packages. Please refer to the software documentation for details.



Ensure you have Administrator access rights in your system before you start with the installation of the software packages. Dialogue Elite users must have read/write access to all software (sub) folders.

Dialogue Elite

To install the software:

- Download the latest version of the Dialogue Exceed from the Antec website www.antecscientific.com (register to get access).
- Double click on the setup.exe file to start the installation wizard
- Follow the instructions of the installation wizard for successful installation of the software.
- Insert the Dialogue Exceed license dongle to get full access to the software (without dongle it will operate in demo mode).
- Make sure that the LAN connection is configured and the LAN cable is connected.
- Power up the potentiostat by means of the mains switch on the rear panel.
- Start the program Dialogue Exceed from the Windows start menu.
- During start-up the 'Select devices' menu will pop-up as shown

below.

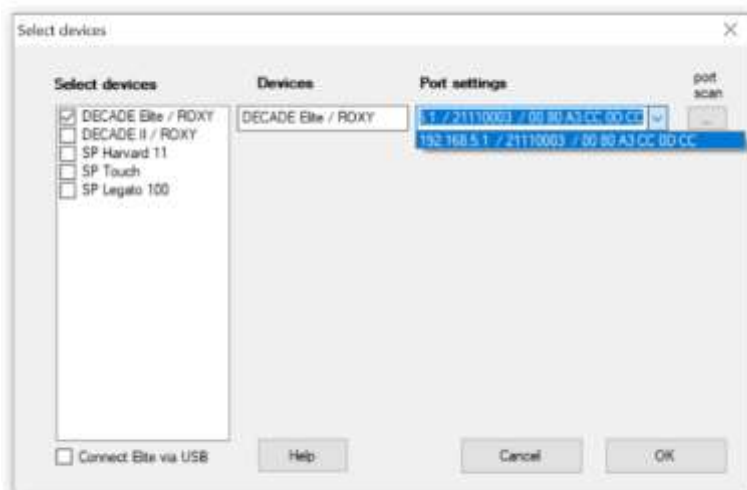

- When a ROXY Exceed potentiostat is available it is automatically detected and the IP address is shown in the port settings box. If not press port scan or type in the default IP address 192.168.5.1.
- The pull down field shows all responding devices with their IP and MAC address. In case of doubt check the device unique MAC address on the rear panel IO connector.
- Type OK. The instrument will connect and is ready for use.

LC connections

In this section the installation & priming of all relevant fluidic connections are described to be able to use the ROXY Exceed to perform REDOX reactions. When working with mobile phase solutions take the following precautions:



Use proper eye and skin protection when working with solvents. The solvents used may be flammable, toxic or corrosive. Organic solvents are toxic above a certain concentration. Ensure that work areas are always well-ventilated! Use of open fire in the vicinity of this system must be strictly prohibited. Do not install the system in the same room with any other equipment that emits or could potentially emit sparks. Wear protective gloves, safety glasses and other relevant protective clothing when working on the device!

With respect to third-party LC equipment, such as LC pumps, auto samplers, injection valves etc. used in combination with the ROXY Exceed Potentiostat. The equipment connected to the system should be specifically designed for use in Liquid Chromatography and capable of delivering flow rates typically in the range between 1 $\mu\text{L}/\text{min}$ up to 1 mL/min .



The manufacturer will not accept any liability for damage, direct or indirect, caused by connecting this instrument to devices that do not meet the relevant safety standards.

Tubing connectors

For optimal operation it is of the utmost importance that all tubing connections on the reactor flow cells are made without introducing dead volumes.

Use only the original polymeric finger tighters supplied by Antec with the purchased EC flow cell to make LC connections on the flow cells inlet and outlet. Do not use metal tubing on the flow cell because it may lead to damage or incorrect operation of the flow cell. Use PEEK, PEEKsil or Fused Silica tubing (with FEP sleeves).

The ROXY™ EC system requires a syringe pump to deliver mobile phase or sample solution. In case the ROXY Exceed was purchased as a part of an ROXY EC system the instrument is shipped with a complete set of dedicated tubing assemblies (LC connection kits) tailor-made for the application and syringe pump (except the ROXY HDX system).

Flow cells

Consult your EC flow cell manual for installation details. Connect the cell to the corresponding cell connector in the oven compartment. All cell connectors are marked with a label for identification. In case of a ROXY Exceed SCC connect the flow cell to the cell connector on the left side marked "Cell 1".



The cell connector inside the oven compartment is ESD sensitive. Make sure that the flow cell is OFF when removing or connecting the cell cable.

Never switch ON the flow cell when:

- (1) the cell cable is not correctly connected,
- (2) the cell is only partly (or not at all) filled with mobile phase, containing electrolyte (e.g., ammonium formate, formic acid)
- (3) the outside of the flow cell is wet, particularly the part between the auxiliary and working electrode connection, because substantial damage to the working electrode or electronics may occur.

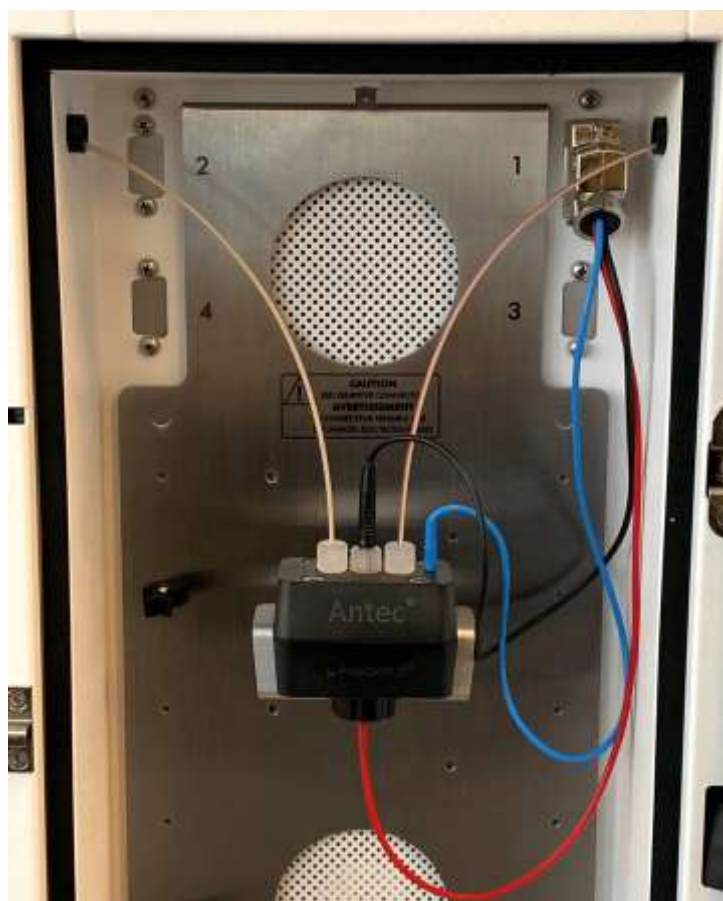

Fig. 4. μ -PrepCell 2.0 mounted in cell clamp in the oven compartment of the potentiostat. Cable connections: WE contact (red wire), AUX contact (blue) and REF contact (black wire).

1. Before switching ON the cell, make sure that the buffer contains sufficient electrolyte (buffer ions). A stable working conditions will never be obtained if the cell is switched ON with only water or another non-conducting mobile phase. Also be sure that no air bubbles are trapped in the electrochemical cell.
2. Set the cell potential (see chapter 9 for optimization of the potential), switch ON the flow cell to oxidize or reduce the sample.

Your system is now ready for use.

CHAPTER 3

Maintenance, checks & shutdown

Maintenance

In this paragraph all maintenance is described which can be performed by the end-user, all other maintenance & service procedures may only be performed by authorized service engineers only.

Periodic check for leakage

Perform leak checks on LC tubing, flow cells and connections on a daily basis and check if the drain on the bottom of the oven compartment is not blocked or closed. Do not allow flammable and/or toxic solvents to accumulate. Follow a regulated, approved waste disposal program. Empty and clean waste container regularly. Never dispose of such products through the municipal sewage system. Check daily that the mobile phase bottles contain enough mobile phase for the number of analysis planned to be Executed.

Periodic check of the oven temperature

The operator should check/verify on a daily basis if the actual oven temperature is in accordance with the set temperature of the ROXY Exceed.



In case the actual temperature exceeds 70°C switch off the potentiostat immediately do not touch the metal parts inside the oven compartment because they could be hot, and contact the manufacturer or its representatives for service. Do not use/switch on the instrument before the instrument is serviced at the factory.

Flow cell

Check the performance of the potentiostat & flow cell on a daily basis by evaluating the background current, noise and signal. An increase in background current, noise and/or loss of reaction conversion efficiency may be a sign of contamination of the working electrode (WE). Detailed information about flow cell maintenance instructions are described in the user manual supplied with the specific flow cell (ReactorCell, μ -PrepCell etc.) purchased in combination with your potentiostat.



Cleaning

In general, the ROXY Exceed needs very little maintenance. The outside of the potentiostat may be cleaned with a non-aggressive cleaning liquid.



Do not use any organic solvents to clean the exterior of the potentiostat, because this may lead to damage of the paint layer.

In case of leakage in the cell cabinet (tubing, connectors, cell, column etc.) remove the spilled mobile phase or other solutions as soon as possible because this may damage the paint layer, or result in the deposition of salt crusts (in case of buffered mobile phases), which could block the drain in the bottom of the cell cabinet. Remove any dust on the protective screens that cover the fans in the oven compartment.

Replacement of fuses



Replace blown fuses with fuses of proper type and rating as stipulated on the rear panel and specified in the installation section of this manual. The fuse holder is integrated in the mains connector. Ensure that the instrument is never put in operation with fuses of a different type. This could cause fire.

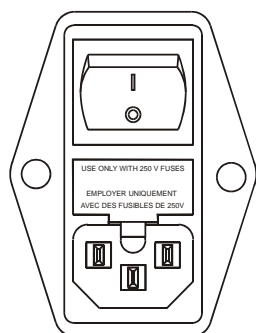

V ~ 100-240 V	FUSE RATING	 WARNING - RISK OF FIRE REPLACE FUSE AS MARKED AVERTISSEMENT - RISQUE DE FEU REMPLACEZ LE FUSIBLE COMME INDIQUÉ
50 - 60 Hz		
260 VA	2.5AT / 250V	

In case the fuses blow out repetitively contact Antec or its representatives for instructions and/or service of the instrument.

Shutting down the system

There are a couple of steps to take to switch off an LC system with electrochemical potentiostat for a longer period of time. Shutting down is not different from most other HPLC systems. Perform the following procedure:

- Switch off the flow cell using the keyboard (standalone) or via the software (Dialogue Elite).
- If a column is installed, check the column(s) documentation for the appropriate storage liquid, apply this and make sure the column is properly flushed. A reversed phase C18 column is usually stored with 50% Acetonitrile/water.
- Take out the column, mount the corresponding end-caps and store the column in an appropriate place.



Avoid precipitation of high salt concentrations in organic solvent, first wash out salts with water if necessary.

- Flush and store the system with 50% water/acetonitrile (or methanol). Switch the injector valve between load and inject a few times. Make sure all tubing, filters etc. are flushed so no traces of salt are left that could precipitate and clog the system.
- Remove the flow cell from the system by disconnecting the inlet and outlet capillary.
- Open the cell, flush with water, use some tissues to carefully dry the cell.
- Close the cell and store dry.
- Switch off the potentiostat (and other LC equipment) via the mains switch (switch to position '0') on the rear panel.

CHAPTER 4

ROXY Exceed control

Introduction

The ROXY Exceed has been designed for maximum functionality and ease of use. The control of parameters via the keyboard & LCD display is such that without reading this chapter, it should be possible to operate the potentiostat. This chapter is intended as a reference guide in case questions arise during operation.

The information shown in the numerous screens is presented in alphabetical order. For each item an explanation is given, together with the item's nature and the screen(s) of appearance. The nature of an item can be:

1. Control: parameters with a cursor box ('□') can be attained via cursor buttons and changed by the 'value' button.
2. Status: without a cursor box a parameter reflects the current status.
3. Functions: parameters in CAPITALS are commands accessible via function buttons F1 - F5.
4. The 'Enter' button is only used to accept changes in cell potential. In the top right corner of each screen the name of the present screen is displayed. If available, the bottom left function button displays a previous screen, and the bottom right one the next screen.



Fig. 5. ROXY Exceed keyboard. The cursor is on 'Range' which allows changes using the value buttons '+' and '-'. The 'Enter' button is only used to confirm changes in potential (E_c) and range.

Overview of ROXY Exceed screens

DC mode

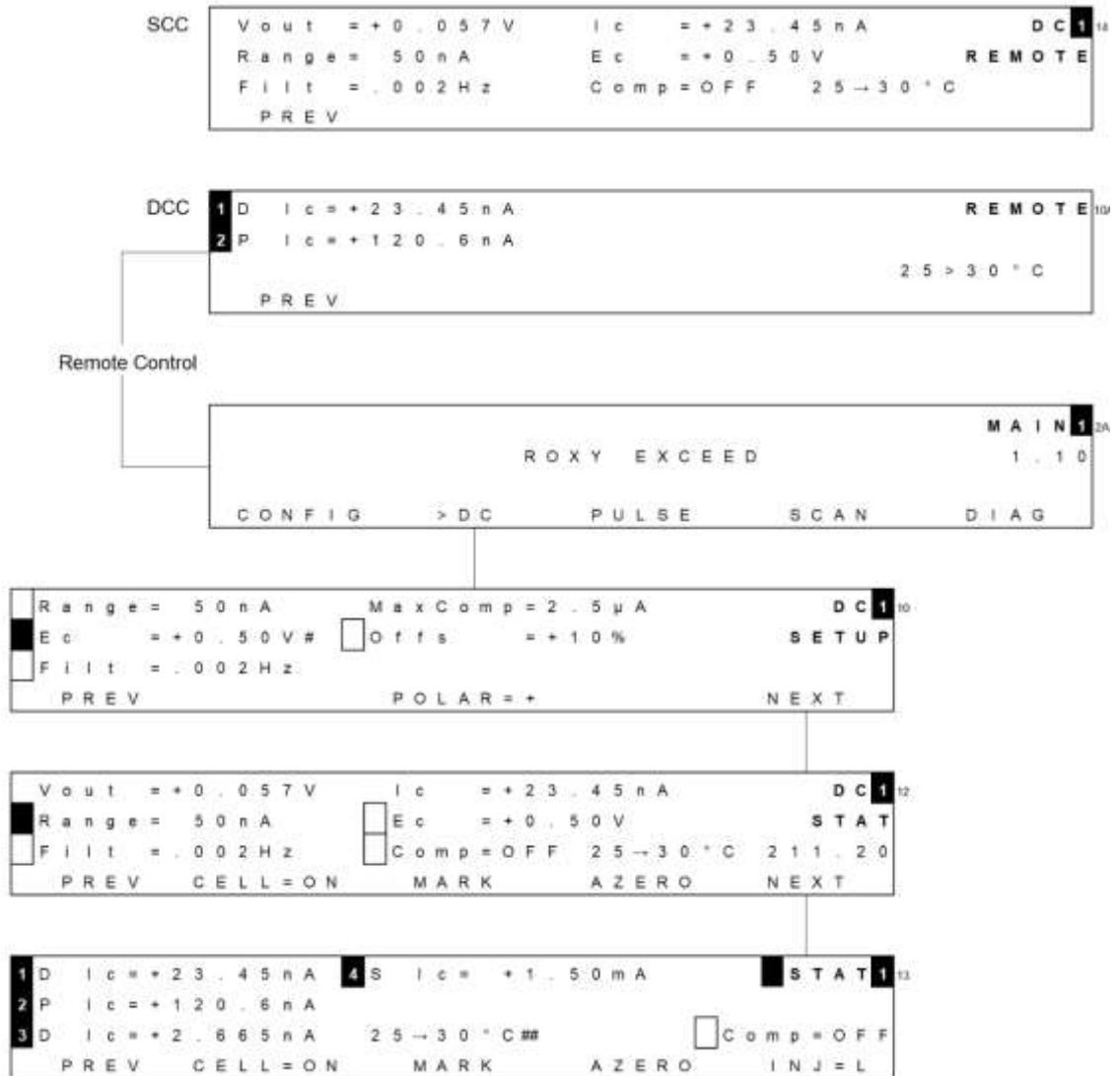

Pulse mode

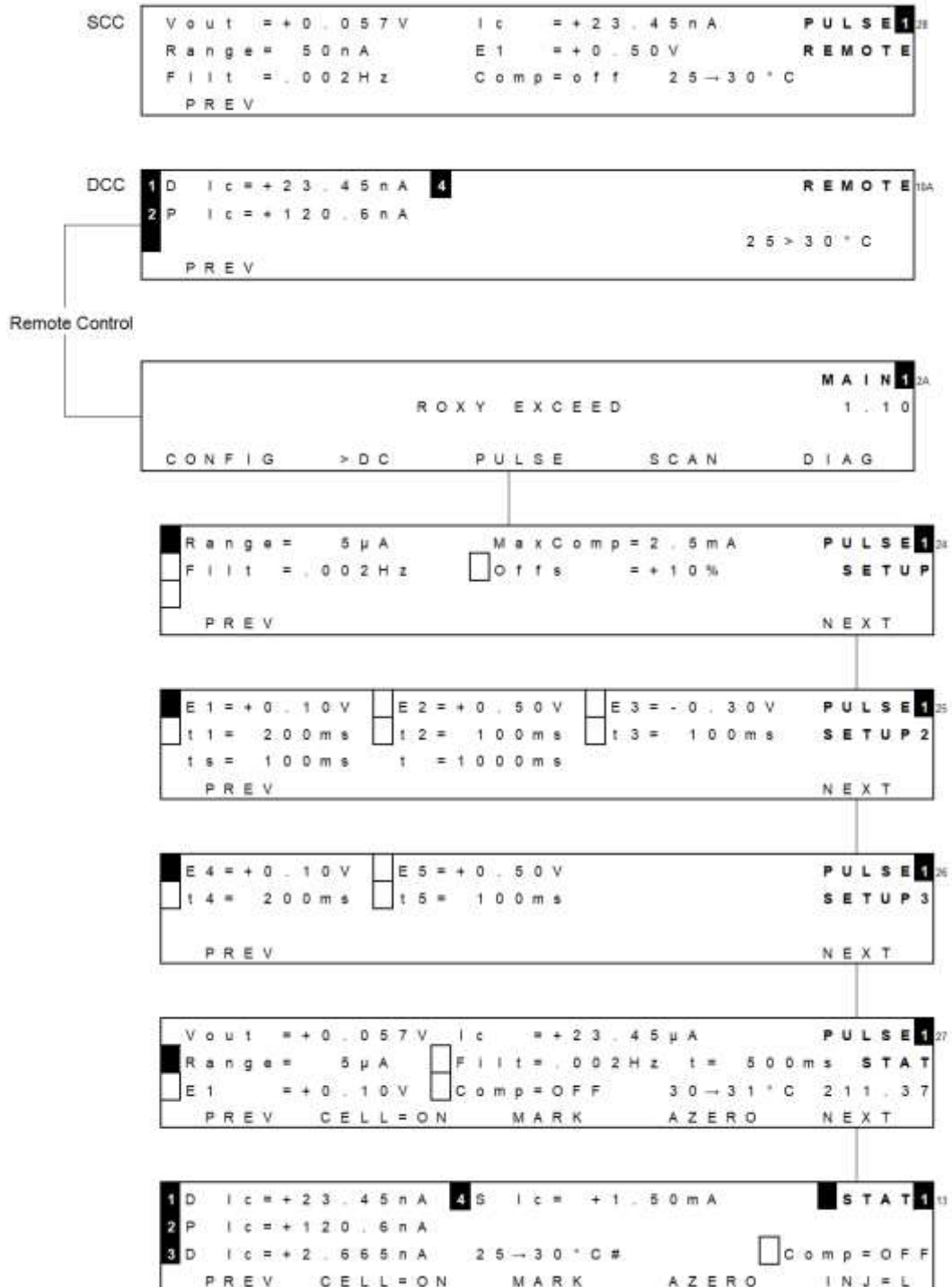

SCAN mode

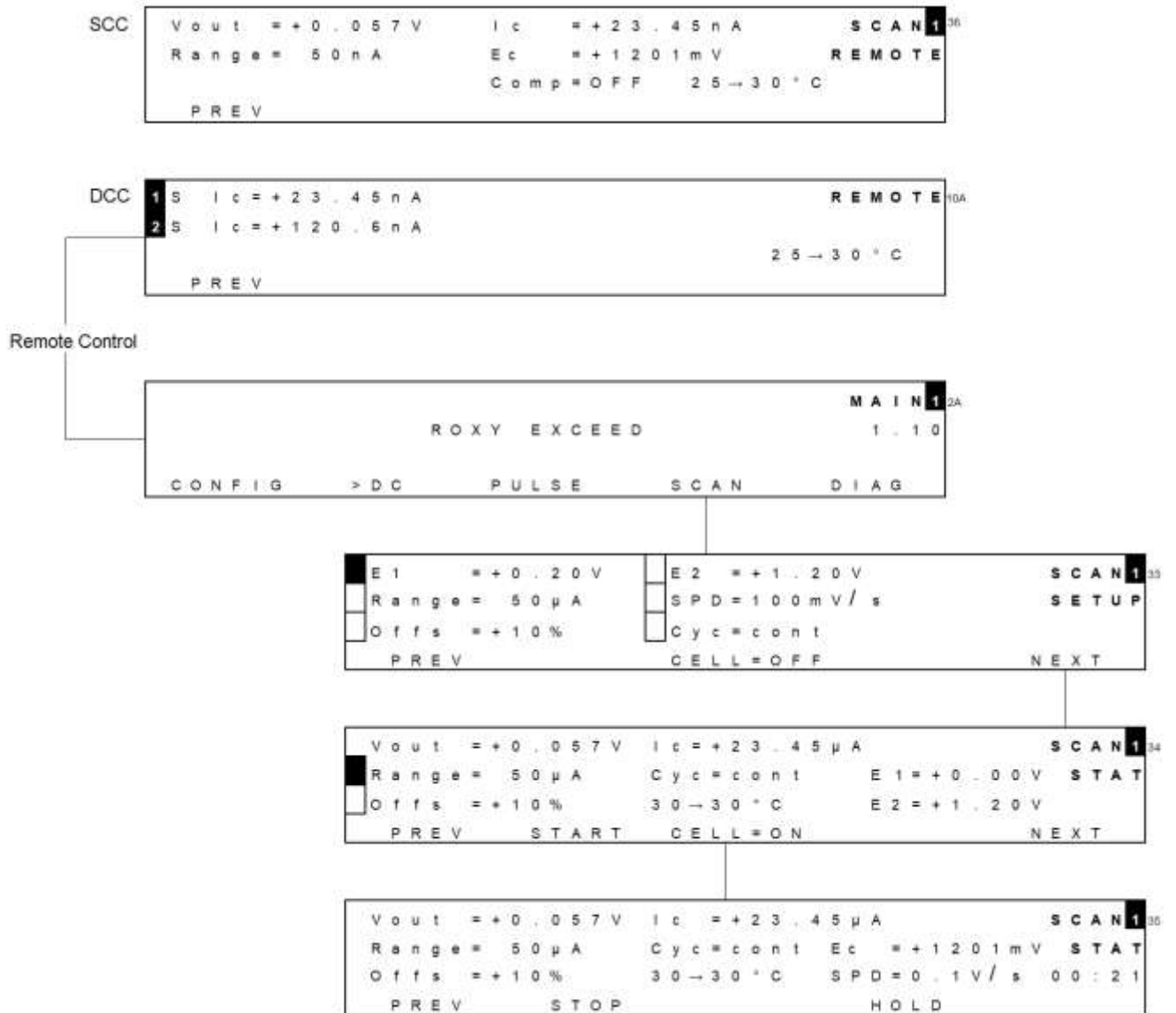

CONFIG menu

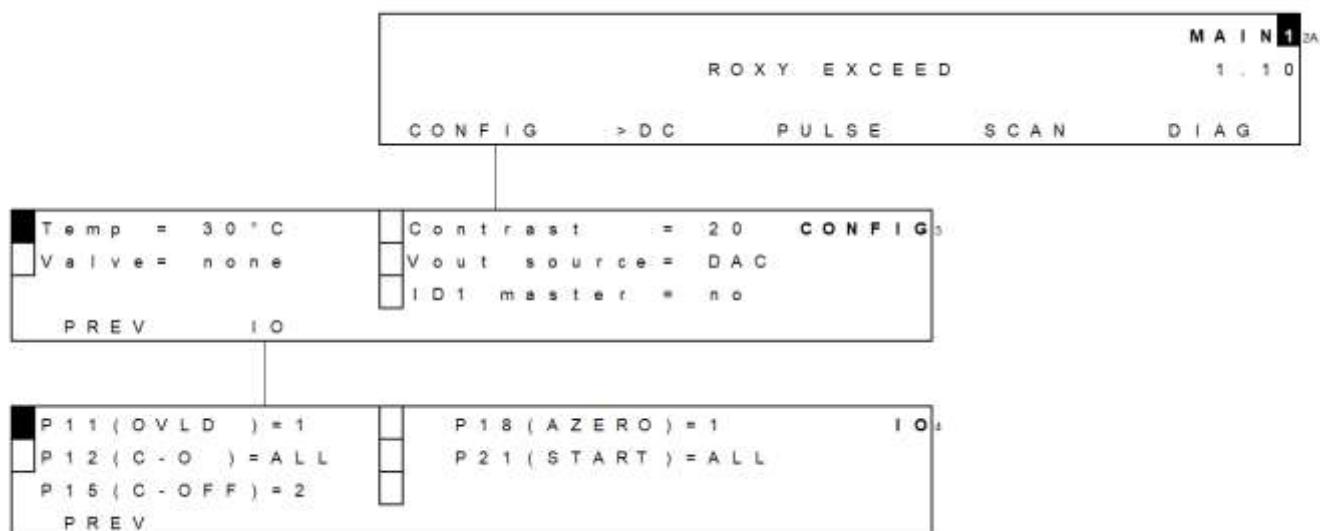

DIAG menu

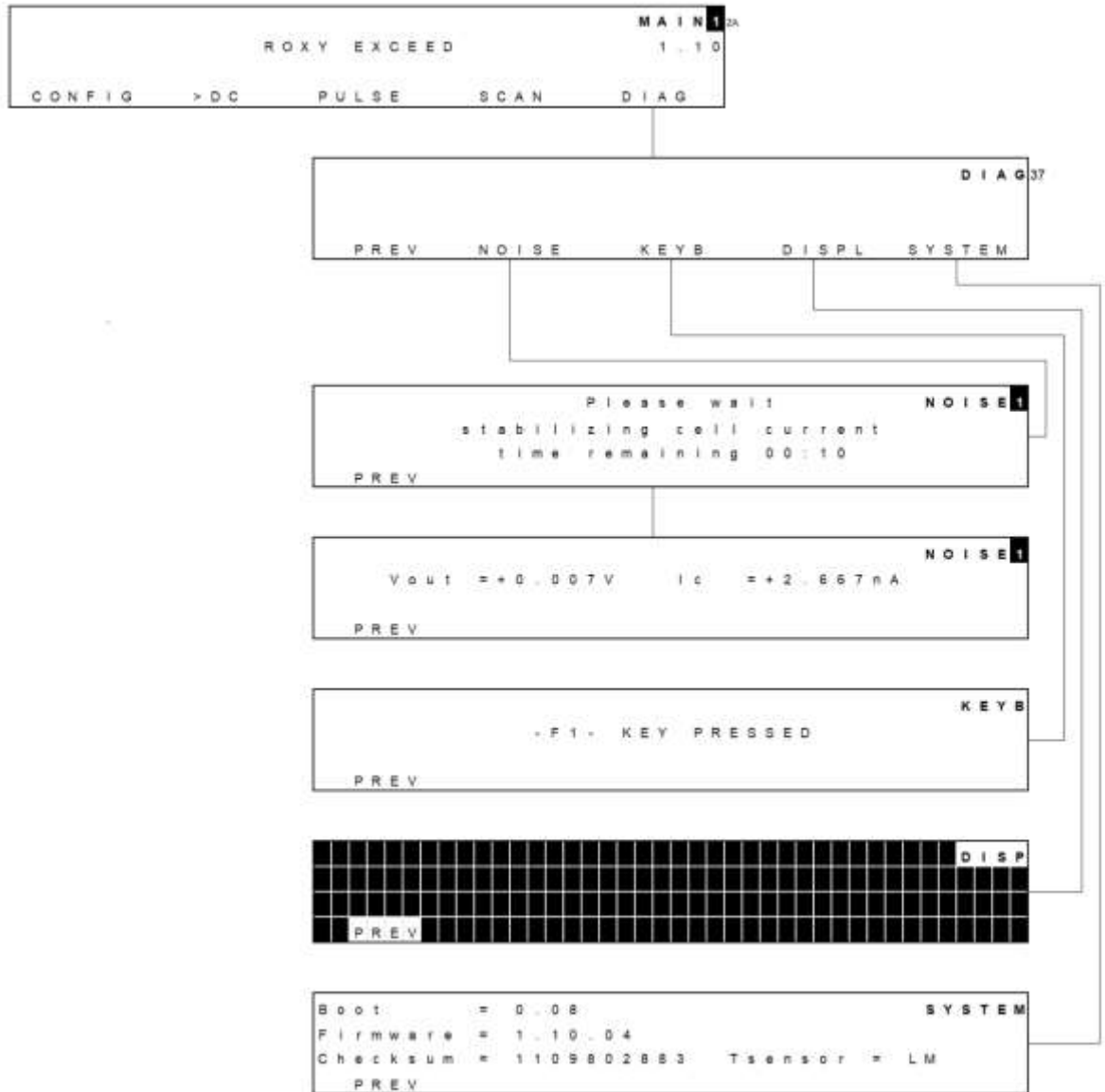

Parameters

Explanation: Type S is status, F is function and C is control.

Parameter	Screen	Description	Type
28 > 30°C	dc stat pulse stat scan stat run	Displays the actual (left value) and the pre-set oven temperature (right value).	S
AZERO	dc stat, run, pulse stat, scan stat	Sets the output voltage to 0 V, or to the offset voltage. Control Comp = off changes to Comp = on. If cell current exceeds the max. compensation a message "cell current exceeds max. compensation" appears. In that case max. compensation will be applied, which may not be the 0 Volt level but higher.	F
Boot	system	Displays boot firmware version	S
CELL=ON/ OFF	dc stat, pulse stat, scan setup, scan stat	Toggles between cell 'ON' and 'OFF'. Confirmation is required "Switch cell on (off)?" Switching on resets the clock to 0.00. Pulse mode: pulsation occurs as long as the cell is on, irrespective which screen is selected. Scan mode: potential E1 is applied.	F
Checksum	system	Displays checksum	S
Comp	dc stat, pulse stat	Toggles between 'ON' and 'OFF', releases auto zero offset. Switches ON if AZERO is pressed. Affects auto zero compensation only, not the % offset!	C
CONFIG	main	Enters config screen	F
Contrast	config	Sets the contrast of display	C
Cyc	scan setup	Controls the nature of the cycle: half, full and continuous. 'Half' means that the cell potential runs from E1 to E2 and stops at E2 (). 'Full' means that the cell potential runs from E1 to E2, and back to E1, and then stops (Λ). 'Cont'	C

Parameter	Screen	Description	Type
		means that the cell potential runs from E1 to E2 and back to E1 continuously (∩∩∩.....). Pressing "STOP" or finishing the cycle, sets the potential to E1.	
DIAG	main	Enters Diag screen	F
DISPL	test	Enters DISP screen for display test.	F
E1, E2, E3, E4, E5	pulse setup2 pulse setup3	Controls the cell potential settings of the pulse. Can be set between +2.50 and -2.50 V with 10 mV steps. Can only be set or changed after confirmation with the 'enter' button.	C
Ec	dc setup	Controls the cell potential, can be set between +2.50 and -2.50 V with 10 mV steps. Can only be set or changed after confirmation with the 'enter' button.	C
Ec	run (dc only), scan stat (during scanning)	Reflects the set cell potential. Displays the actual cell potential in the scan mode.	S
Filt (DC mode)	dc setup, dc stat	Filter settings: RAW (100 Hz), Off (10 Hz) and 1 Hz to 0.001 Hz cut off frequency, in 1, 2, 5 steps.	C
Filt (PULSE mode)	pulse setup, pulse stat	Filter settings: Off and 0.5 Hz to 0.001 Hz cut off frequency, in 1, 2, 5 steps. (Fcut-off / filter coefficients based on 1 Hz input frequency in pulse mode)	C
Filt	run	Reflects the actual filter setting.	S
Firmware	system	Displays firmware version	S
Hold resume	run, scan stat	Toggle, holds or resumes execution of scan.	F
HOLD=0,1	run, scan stat	Holds or continues execution of scan. Toggles between 1 and 0. Pressing hold again continues scan were it has been hold.	F
Ic	stat (dc, pulse, scan), , run, noise	Displays the true, non-compensated cell current, unaffected by auto zero or offset.	S

Parameter	Screen	Description	Type
ID1 master	config	Sets sensor board 1 as master. When this setting is set to 'yes' all parameter settings from sensor board 1 are automatically copied/transferred to all other sensor boards present.	C
IO	Config	Enter IO menu	F
INJ=I/L	dc stat, pulse stat	Displays or switches the position of the injection valve, toggles between inject (I) and load (L). If a manual injector with position sensor is applied, it echoes the position of the injector. If an electrically actuated injector is used (optional) it is possible to switch the injector with this function button.	F/S
KEYB	test	Enters 'KEYB' screen, for keyboard test. Press 2x F1 to leave.	F
MARK	dc stat, pulse stat	Triggers a marker signal on output.	F
MaxComp	dc setup, pulse setup1	Maximum cell current that can be compensated for using auto zero.	S
Next	several screens	Enter next screen	F
NOISE	test	Enters NOISE screen for performance test.	F
Offs	dc setup, dc stat, prog, pulse setup1, pulse stat, scan setup, scan stat	Percentage offset, can be set between -50 and +50%.	C
POLAR	dc setup, pulse setup2	Inverts output polarity, toggle between + and -. Requires confirmation.	F
PREV	several screens	Return to previous screen	F
P11(OVLD)	IO	Programmable output: can be configured that the overload (OVLD) signal of cell 1, 2 or 3 only is present on pin 11 when active or ALL cells.	C

Parameter	Screen	Description	Type
P12(C-ON)	IO	Programmable input: can be configured that only cell 1, 2 or 3 is switched ON when active, or ALL cells.	C
P15(C-OFF)	IO	Programmable input: can be configured that only cell 1, 2 or 3 is switched OFF when active, or ALL cells.	C
P18(AZERO)	IO	Programmable input: can be configured that the signal of cell 1, 2 or 3 is zeroed when active, or ALL cells.	C
P21(START)	IO	Programmable input: can be configured that the data-acquisition on sensor board 1, 2 or 3 is started when active, or on ALL sensor boards.	C
Range	dc setup, dc stat, prog, pulse setup1, pulse stat, scan setup, scan stat	Range setting, varying from 10 pA to 200 μ A full scale, in 1, 2 and 5 steps. In the pulse and scan mode 10 nA to 200 μ A full scale can be used.	C
S	scan setup	Scan speed, can be set from 1 - 100 mV/s in 1, 2, 5 steps.	C
SPD	scan stat	Scan speed, can be set from 1 - 100 mV/s in 1, 2, 5 steps.	C
START	run, scan stat	In DC and pulse mode: toggle between STOP and START execution of a time file. Starts a scan in scan mode.	F
STOP	run, scan stat	Scan mode: STOP aborts scan and resets cell potential to E1. DC and pulse mode: toggle between STOP and START to control execution of a time file. Pressing 'STOP' aborts this run, cycle counter (Cy) is reset to 1. STOP also deactivates the outputs Aux 1 and 2, and Relays 1 and 2 (status: 0000) and sets the electric valve to load (if present).	F

Parameter	Screen	Description	Type
SYSTEM	diag	Enter SYSTEM menu	F
t	pulse setup2, pulse stat	Displays the total duration of one pulse (t1 + t2 + t3 + t4 + t5).	S
t1, t2, t3, t4, t5	pulse setup2 pulse setup3	Duration of potential step E1, E2, E3, E4 and E5. Time can be set between 0 (t2 – t5) or 100 (t1) and 2000 ms in 10 ms increments. Maximum pulse duration is 9999 ms.	C
Temp	config	Controls the temperature of the oven. Range: off, 15 - 60°C, selectable in 1°C steps. The oven is stable from 7°C above ambient oven temperature.	C
Toven	dc setup, pulse setup1	Controls the temperature of the oven. Range: off, 15 - 60°C, selectable in 1°C steps. The oven is stable from 7 °C above ambient.	C
ts	pulse setup2	Controls the duration of the sampling time in the pulse mode. The time can be set between 20 ms and maximum t1-60ms with 20 ms increments.	C
Tsensor	system	Displays active temperature sensor	S
Valve	config	User confirmation whether a manual valve is connected to phone jack C on rear panel. If present: INJ=I or INJ=L appears in DC/Pulse Status screen	S
Vout	stat (dc, pulse, scan), run, noise	Displays output signal.	S
Vout source	config	Sets the output source from the analog data output: DAC (processed digital signal after 16-bit AD conversion) or I/E (true analog signal from the I/E converter)	S

Dialogue Elite

Dialogue Elite for Windows is a multi-functional program to control the ROXY Exceed potentiostat. Additionally, Dialogue Elite can control a Harvard 11 or Legato 100 syringe pump for the delivery of sample solution.

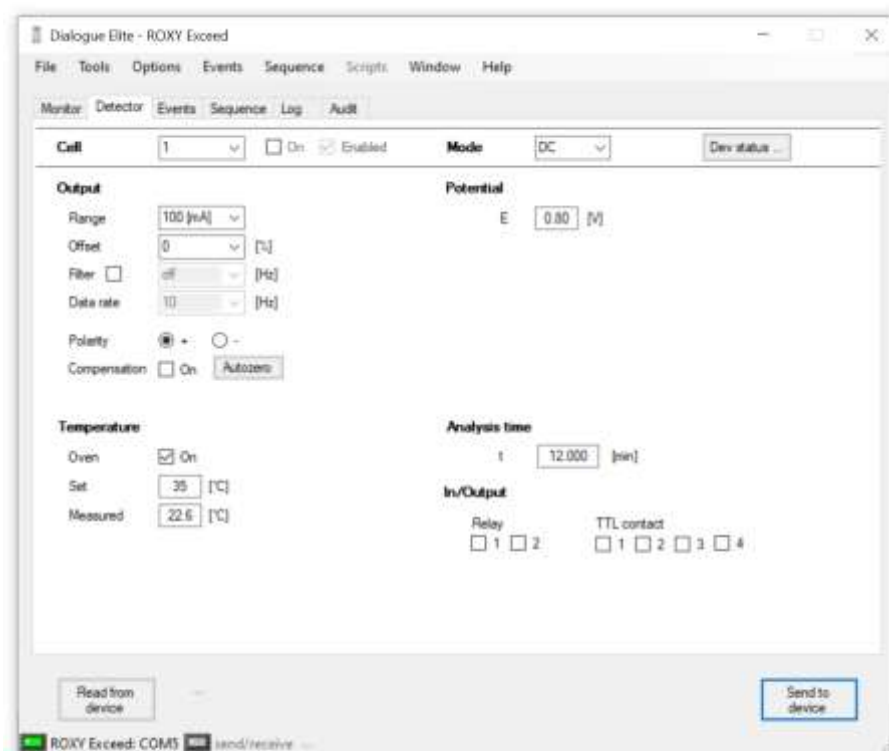

Fig. 7. ROXY Exceed potentiostat window in Dialogue Elite (DC mode). On the potentiostat tab the main measurement conditions can be set/controlled (measurement mode & potential settings)

Dialogue Elite is a tool for:

- controlling all operational parameters
- programming timed events in one run or sequence*
- scanning voltammetry
- firmware upgrades using the FW upgrade wizard
- OQ, PQ and dummy cell measurements
- device calibration

) The software package contains a set of event table files (.evt) for the automated recording of mass voltammograms and sample oxidation or reduction. The example methods provided can be easily adapted to suite your requirements/experiment.

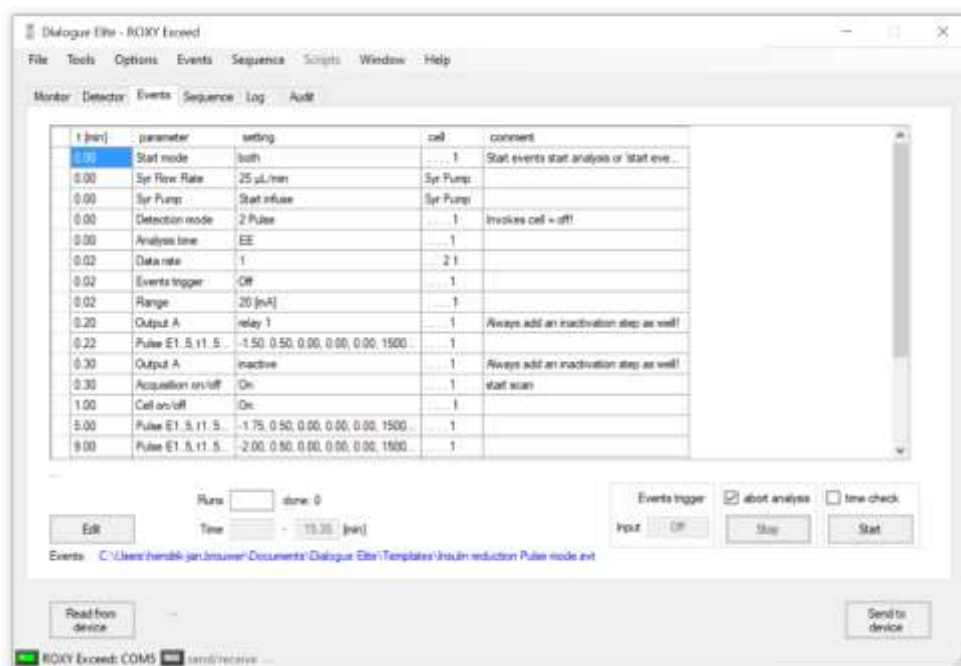

Fig. 8. Dialogue Elite events programming window for ROXY Exceed.

There are no tools for further data analysis, therefore Dialogue cannot be considered as fully featured chromatography software package. The free demo version of this program has already all functionality implemented, functionality is unlocked by a license dongle.

The **free version** is primarily used for controlling all operational parameters of the potentiostat. The free version cannot be used for starting a run, running a calibration or OQ.

For details about the use and functionality of the Dialogue Elite software please refer to document 175.0015 Dialogue Elite user manual which can be downloaded from the Antec website (www.antecscientific.com).

Chromeleon CDS

Full control and data acquisition of the DC and Pulse measurement mode for the DECADE Elite and ROXY Exceed is supported in Chromeleon CDS version 7.2.5 and higher (ThermoFisher Scientific, USA). The driver will become available in the first half of 2020.



Fig. 9. Chromeleon console showing a ROXY Exceed e-panel with method settings and acquisition window.

Within a Chromeleon instrument method it is possible to execute timed event by programming time lines. Running a Time table enables time-based automated parametric control of the Exceed potentiostat. This is particularly useful when during a run, parameters such as the cell potential settings have to be changed, to set for example the optimal oxidation potential for different target compounds eluting during a run.



The SCAN mode is not supported in Chromeleon CDS. Scanning Voltammetry is supported in the Dialogue Elite software only.

For details about the requirements, use and functionality of the ROXY Exceed control driver in Chromeleon please refer to document 176.0108 DECADE Elite – ROXY driver for Chromeleon CDS user manual, which can be downloaded from the Antec website (www.antecscientific.com).

CHAPTER 5

Operation modes & Parameters

Three- or two electrode configuration

The circuitry of the ROXY Exceed potentiostat is designed for operation with electrochemical flow cells with both a two or three-electrode configuration (Fig. 10). In a three-electrode configuration the working potential is set between the working electrode (WE) and the auxiliary electrode (AUX). The AUX is kept at a precisely defined reference electrode (REF) potential by means of the so-called voltage clamp. This is an electronic feedback circuit that compensates for polarization effects at the electrodes.

At the WE, which is kept at virtual ground, the electrochemical reaction takes place, i.e. electrons are transferred at the WE. This results in an electrical current to the I/E converter, which is a special type of operational amplifier. The output voltage of the I/E converter is digitized in the instrument by means of a 24-bit A/D converter and processed, and the resulting output current I_c can be acquired digitally by PC control software (Dialogue Elite or Chromeleon CDS) or analog using the 'Analog Data output' on the rear panel connected to a recorder or an external A/D converter.

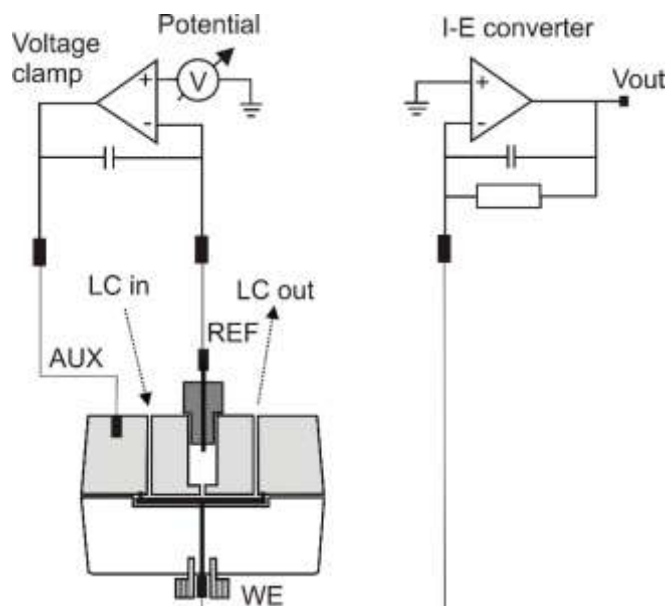

Fig. 10. Schematic representation of an electrochemical cell and potentiostat electronics operating with a three-electrode configuration.

Essentially, for the oxidation or reduction reaction it would be sufficient to use only two electrodes. However, the three-electrode configuration has several advantages over a two-electrode configuration. If the working potential would be applied only over an AUX versus the WE (without REF), the working potential would continuously change due to polarization effects at the electrodes, resulting in highly unstable working conditions.

If the working potential would be applied only over the REF versus the WE (without AUX), the working potential would be very well defined. However, the potential of a REF is only well defined if the current drawn is extremely low (pico-amperes) resulting in a very limited dynamic range.

A three-electrode configuration, combines the best of both electrodes. The REF stabilizes the working potential and the AUX can supply high currents. This results in the tremendous dynamic range of a three-electrode system.

For some ROXY applications like the reduction of disulfide bridges in proteins and peptides a two-electrode configuration is used for efficient reduction. See figure below.

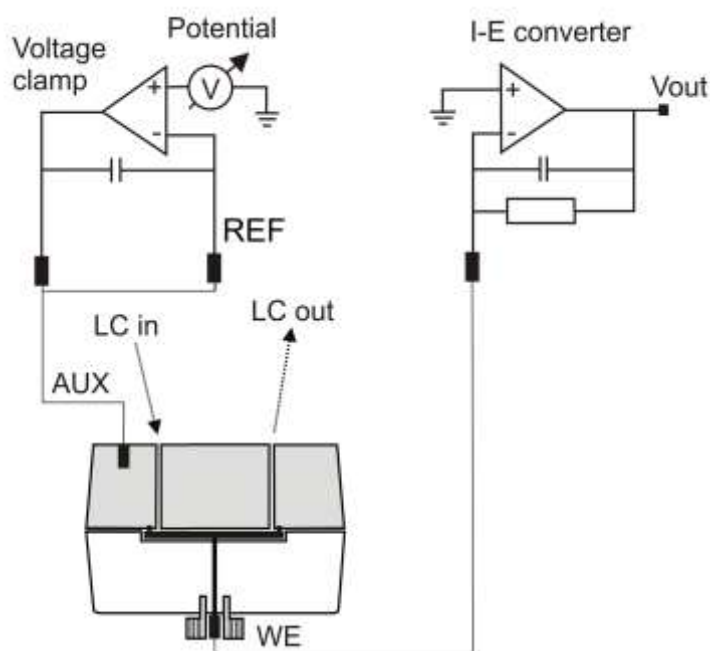

Fig. 11. Schematic representation of an electrochemical cell and potentiostat electronics operating with a two-electrode configuration.

Internal organization

At the working electrode (WE) in the electrochemical flow cell the electron transfer takes place due to an oxidation or reduction reaction. The resulting electrical current is amplified by the current-potential (I/E) converter (Fig. 12).

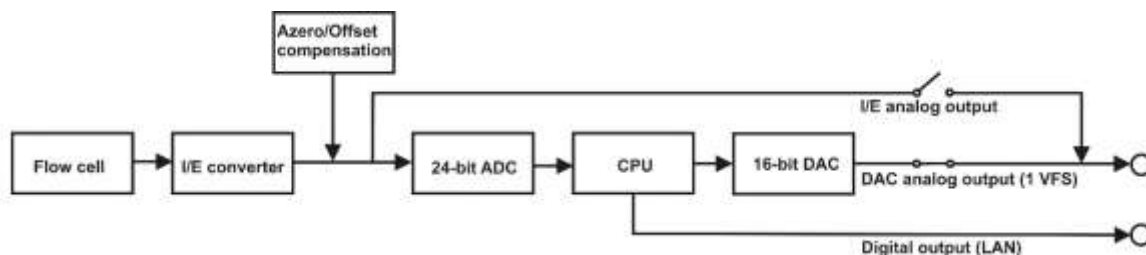

Fig. 12. ROXY Exceed signal processing from EC flow cell to output.

The signal from the I/E converter can be compensated with auto zero or offset, and is digitized using a 24-bits ADC. In the CPU the signal is processed, for example noise filtering, or more complex data processing in PAD. Finally after the 16-bits DAC the signal is set to a 1 V full scale analog data output (by default Output = ADC). Also the true analog signal from the I/E converter (before AD conversion) is available via the 'Analog data output' connector. This output can be selected in the CONFIG menu by setting the parameter Output = I/E.

Dual flow cell control

The ROXY Exceed electronics are located on 2 different PCB's (printed circuit boards). The *control* board and the *sensor* board. The control board is dedicated to communication with PC (LAN) and keyboard & display. It has a processor with a so called 'event handler' that takes care of all user commands and hardware interrupts. The sensor board is fully dedicated to data acquisition and flow cell control. By using this architecture it is possible to extend the functionality of the potentiostat to more than one flow cell by simply adding a sensor board. The ROXY Exceed can be equipped with up to two sensor boards (DCC). Typically, in a dual EC flow cell configuration one can work in a serial or parallel configuration.

Serial mode detection

In serial mode two EC flow cells are installed in series. For data acquisition 2 data channels are applied with the same time base. Serial mode operation is especially suitable to increase the conversion yield of an electrochemical reaction.

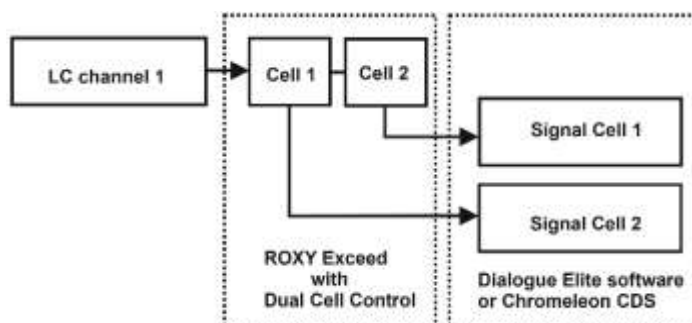

Fig. 13. Configuration for serial mode operation. Cell 1 and Cell 2 can be a ReactorCell or μ -PrepCell. The LC channel can consist of a single syringe pump for delivery of target compound or a complete (U)HPLC setup with injector and column.

Parallel mode detection

In parallel mode two EC flow cells are installed in parallel using two separate LC. For data-acquisition of the two signals one time base is used.

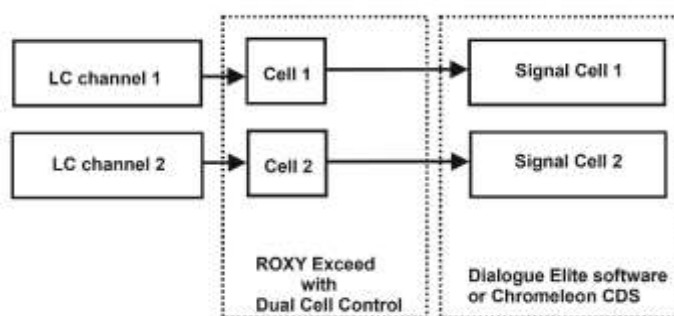

Fig. 14. Configuration for parallel mode operation. Cell 1 and Cell 2 can be a ReactorCell or μ -PrepCell. The LC channels can consist of a single syringe pump for delivery of target compound or a complete (U)HPLC setup with injector and column.

Navigation in dual cell menu

All menus for a dual flow cell system are similar to a single cell system with 2 exceptions. First, in the top right corner a number is visible which indicates the active cell in display. Toggle with the "+" and "-" buttons between sensor boards. If the board number does not change it means that the second sensor board is not installed or not properly recognized. Second, a new status screen is available in dual cell systems which indicates the status of both cells in a single screen. However, for convenience it is advisable to use PC control from the Clarity Chromatography software or Dialogue Exceed software when working with 2 flow cells.

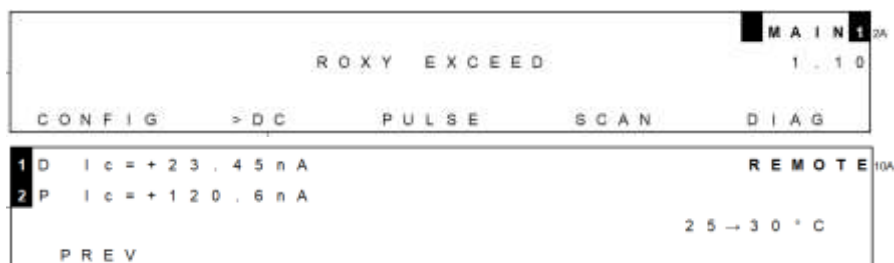

Fig. 15. ROXY Exceed main menu (top) with active cell indicator in top right corner. Multi-STAT screen showing cell 1 (DC mode) and cell 2 (PULSE mode).

Parameters

Operational parameters are controlled from the SETUP screens in the ROXY Exceed. Parameters are filter, cell potential and offset. Temperature is set in CONFIG menu.

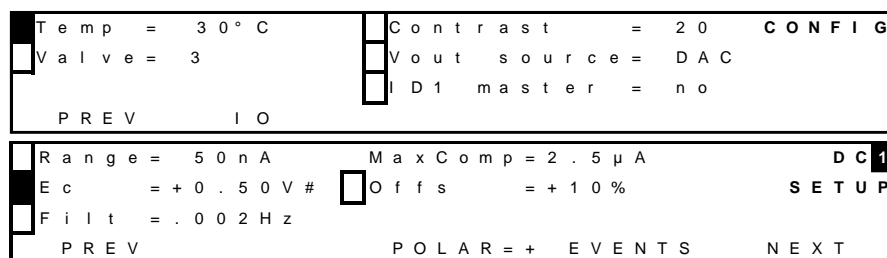

Fig. 16. Selection of parameters in the 'DC SETUP' screen. Temperature is set in CONFIG menu.

Range

Range selection is done in the 'SETUP' or 'STAT' screen in DC, PULSE and SCAN mode. A number of ranges can be selected; the maximum current that can be compensated for using auto zero and offset differs. The high sensitivity ranges (1 nA - 10 nA) have the best noise specifications. In fact, there is a trade-off between best noise specification at sensitive ranges, and maximum compensation at the less sensitive ranges. This is an inevitable consequence of the tremendous dynamic range that is covered by the potentiostat.

Table II. DC ranges and maximum compensation.

Range FS	Max comp	Range FS	Max comp
100 mA ⁽¹⁾	250 mA ⁽²⁾	5 μ A	25 μ A
50 mA	250 mA	2 μ A	25 μ A
20 mA	250 mA	1 μ A	25 μ A
10 mA	25 mA	500 nA	25 μ A
5 mA	25 mA	200 nA	25 μ A
2 mA	25 mA	100 nA	250 nA
1 mA	2.5 mA	50 nA	250 nA
500 μ A	2.5 mA	20 nA	250 nA
200 μ A	2.5 mA	10 nA	25 nA
100 μ A	2.5 mA	5 nA	25 nA
50 μ A	2.5 mA	2 nA	25 nA
20 μ A	2.5 mA	1 nA	25 nA
10 μ A	25 μ A		



(1) Although a range can be selected of 100 mA, the actual maximum current which can be measured by the potentiostat is 35 – 50 mA depending on the measurement conditions.

(2) 250 mA is the theoretical maximum compensation which can be applied in these ranges, the practical maximum compensation is limited by the maximum current which can be measured by the potentiostat (see point 1).

In the PULSE and SCAN mode the current is much higher than in DC mode. Therefore it is not possible to select ranges below 200 nA. See Table III on the next page.

Table III. PAD ranges and maximum compensation.

Range FS	Max comp	Range FS	Max comp
100 mA ⁽¹⁾	250 mA ⁽²⁾	100 μ A	2.5 mA
50 mA	250 mA	50 μ A	2.5 mA
20 mA	250 mA	20 μ A	2.5 mA
10 mA	25 mA	10 μ A	25 μ A
5 mA	25 mA	5 μ A	25 μ A
2 mA	25 mA	2 μ A	25 μ A
1 mA	2.5 mA	1 μ A	25 μ A
500 μ A	2.5 mA	500 nA	25 μ A
200 μ A	2.5 mA	200 nA	25 μ A

For caption (1) and (2) see explanation below Table II.

When using Dialogue Elite software to control and operate the potentiostat only the ranges in 10 steps can be selected.

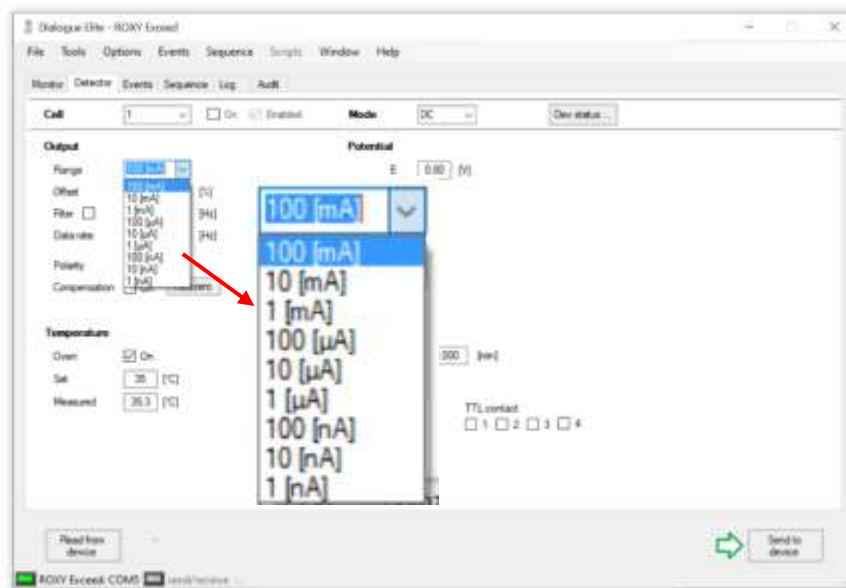

Fig. 17. Range selection in Dialogue Elite for the ROXY Exceed.

Offset

A maximum offset of +50% and - 50% in 5% steps can be set. For example, 20% is a 200 mV offset when the maximum output is 1.0 Volt.

Polarity

The polarity of the output can be inverted. Oxidative and reductive analyses generate opposite currents. For data acquisition, traditionally chromatographic signals have a positive amplitude. Therefore selection of polarity can be useful.

Filter

The ROXY Exceed is equipped with ADF (Advanced Digital Filter) as a tool to smoothen the current signal. High frequency noise is efficiently removed with ADF and will result in a less noisy current signal.

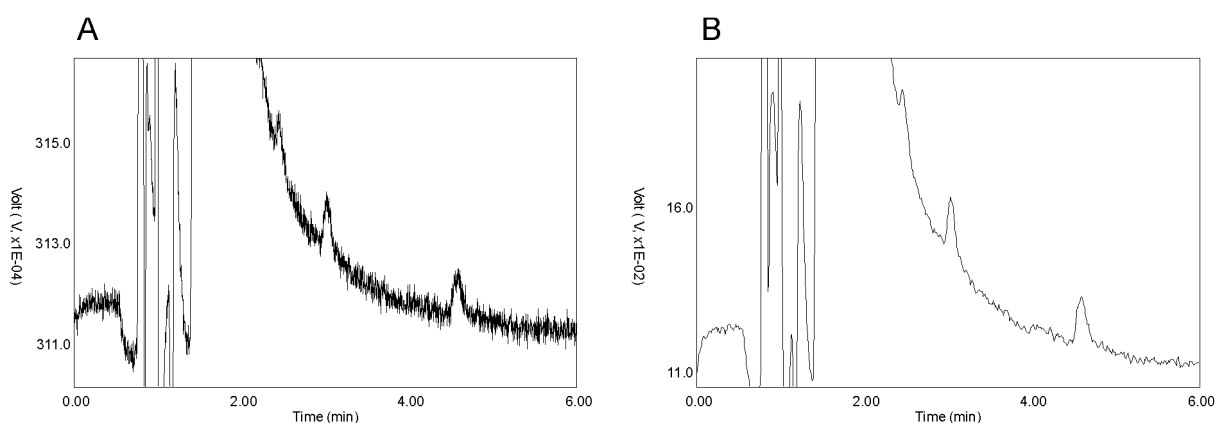

Fig. 18. Signal to noise ratio is improved using a filter (A vs. B).

DC mode

In the tables below the available filter settings for the DC mode are listed with the corresponding data rate of the output. Data rate is expressed as number of data points per second (Hz). In the DC mode the data rate is not an adjustable parameter but is coupled to the filter setting, except for RAW. RAW is special, the incoming data are not filtered and a data rate between 1 and 100 Hz can be selected.

Table IV. DC mode filter setting and corresponding data rate.

Filter setting DC mode (Hz)	Data rate (Hz)
RAW	100(default), 50, 20, 10, 5, 2, 1
10	100
5	50
2, 1	20
OFF	10
0.5, 0.2, 0.1	10
0.05	5
0.02	2
0.01, 0.005, 0.002, 0.001	1

Filter OFF is also a special case. The data rate is fixed to 10 Hz, and the data is not filtered. Setting OFF is therefore the same as RAW at 10 Hz.

Pulse mode

In the pulse mode the working electrode is dynamically and continuously regenerated by a series of potential steps in a cyclic manner. Data is processed differently, and the data rate is defined by the total duration of the 5 potential steps in a pulse: $t_1 + t_2 + t_3 + t_4 + t_5$. Usually the typical pulse duration is between 0.5 and 2s (data rate between 2 – 0.5 Hz). Filter settings in the pulse mode are therefore selectable between 0.5 and 0.001 Hz, and OFF. In Pulse mode 2 filter settings in the range of 0.5 and 0.01 Hz are selectable.

The scan mode has no filter at all.

Autozero

In the STAT screen the Autozero function (F4) is available. For the DC mode this screen is shown below.

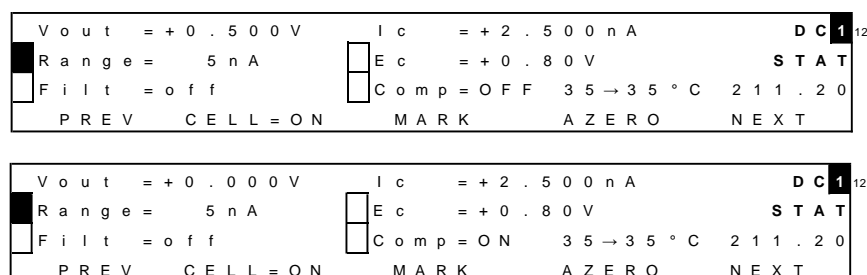

Fig. 19. Stat screen in DC mode. Top: compensation off. Bottom: after executing an Autozero (Function button F4).

The Autozero function can be used to set the output voltage of the I/E converter (signal) to 0 Volt. This is done by means of a compensation amplifier in the analog measurement circuitry, see Fig. 12. This compensation circuitry enables the possibility to measure small current signals (analyte peaks) in a sensitive range even if the background cell current is high. For example with a background current of 20 nA one can still do measurements in the 1 nA range, because the maximum compensation for that range is 25 nA.

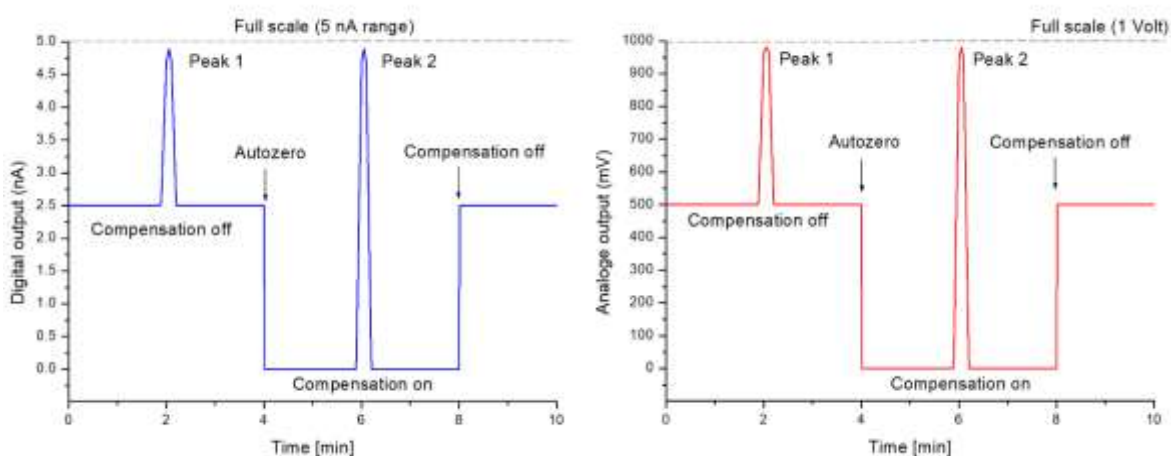

Fig. 20. Example run of the analog (right) and digital output (left) of the detector without and with compensation on. At $t = 4$ min an autozero is executed at $t = 8$ min the compensation is switched off again.

To illustrate how an autozero affects the different detector signals (I_c , analog output V_{out} and digital cell current), an example is given in figure 19 & 20 using the 5 nA measurement range. In the top screen of figure 19 a cell current I_c of 2.500 nA is displayed and no compensation is applied. I_c is the so-called uncompensated cell current and represent the actual current of the cell. The analog output signal corresponding to a current of 2.5 nA is $V_{out} = 2.5\text{nA} / 5\text{ nA} * 1\text{ V (full scale)} = 500\text{ mV}$. The first 4 minutes of the example run in figure 20 correspond to this condition. At $t=4\text{ min}$ an autozero is issued. As can be seen from the bottom screen in Figure 19, the analog output Voltage, V_{out} , became 0 and the Compensation state is now changed to Comp=ON. The I_c remained unchanged (2.500 nA) because it always shows the actual current of the cell, regardless the compensation state.

It is evident from the plots in figure 20 that using the compensation has an advantage. Without compensation, one only has half of the range available for the measurement of an analyte response. So only signals with a peak height of a maximum of 2.5 nA can be measured in this particular case (see peak 1 in figure 20). With the compensation ON the full measurement range of 5 nA is available for the measurement (peak 2).



Do not execute an autozero, offset or range change when the cell current is not stable or the baseline did not stabilize.

In case an Autozero, Offset or a change of range is initiated on an instable or changing current signal (baseline), this may lead to the display of an erratic current value or erratic offset in current. This is expected behavior. An Autozero, offset or change of measurement range will trigger an internal calculation procedure in the detector based on the actual cell current. This is an iterative process and the cell current is measured several times during the calculation process. In case the cell current is not stable during the calculation process this might lead to errors.



Remedy: In the event it does happen, the issue can be simply solved by setting the Compensation to OFF (Comp = OFF) in the STAT screen or CDS control software. Subsequently, wait till the background current is stable/stabilized and execute an Autozero again. The detector should now display the correct current again.

In case event tables are programmed in LC methods in the CDS software with an Autozero action, make sure that the autozero is programmed in a part of the chromatogram where the signal is stable. So at the beginning of the run, during the hold-up time (so before the unretained/solvent peak elutes). Or at the end of the run.

CHAPTER 6

Measurement modes

DC mode

In Direct Current (DC) mode a static potential is constantly applied to the EC flow cell to establish an electrochemical oxidation or reduction reaction of a target compound. In DC mode the resulting current signal is continuously measured and sent to the potentiostat output.

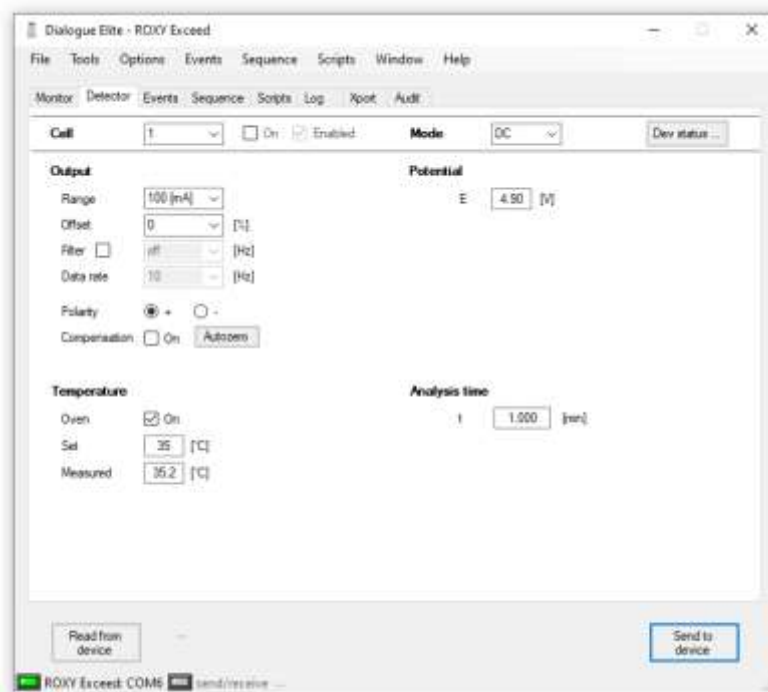
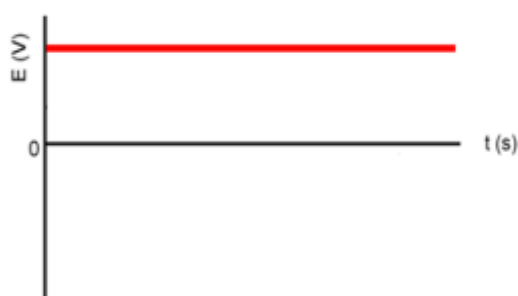

Fig. 21. Top: Plot of cell potential versus time. Bottom: DC mode method settings window in Dialogue Elite. The potential (top right) can be set between -4.9 and +4.9 Volt.

The DC mode can be used for oxidation and reduction reactions using relatively inert working electrode (WE) materials such as Glassy Carbon (GC) or Boron-Doped Diamond. Suitable target compound in this case are typically aromatic compounds with functional groups which can be easily oxidized at relatively low potentials. In addition, one other requirement for successful operation in DC mode is that the target compounds and reaction products should not easily adsorb or contaminate the electrode surface leading to inactivation of WE electrode activity and subsequent loss of conversion efficiency of the electrochemical reaction.

Pulse mode

Besides the DC mode the ROXY Exceed can also be operated in Pulse mode. The pulse mode is quite different from the DC mode. Instead of a constant potential, a series of potential steps is applied in a cyclic manner. The signal is sampled during a fraction of the total pulse cycle. During the sampling time (t_s) the signal is collected and this value is sent to the potentiostat output. The frequency of data output is determined by the pulse duration: $t_1 + t_2 + t_3 + t_4 + t_5$. Usually the duration is between 0.5 and 2s (data rate between 2 – 0.5 Hz).

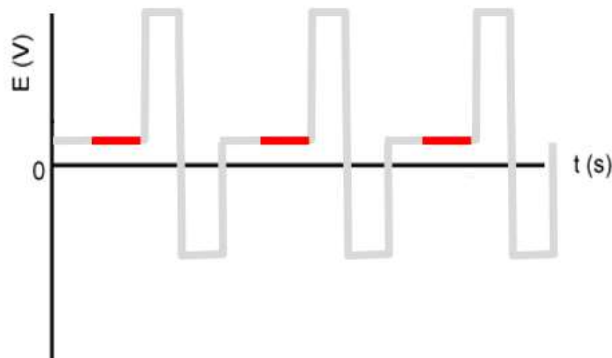

Fig. 22. Pulse mode example: Plot of a three-step potential waveform (grey curve) versus time. Red part: time during which the current signal is measured.

This mode is particularly useful for certain applications where the working electrode is rapidly fouled due to adsorption of reactant or reaction products or/and when using metal electrodes like gold, platinum, titanium elec-

trodes etc. Metal electrodes are the electrodes of choice for oxidation/reduction of aliphatic compounds with functional groups. Such compounds are hard to oxidize on inert electrode materials. Due to surface adsorption of the target compound on metal electrodes the activation energy barrier for the reaction is lowered allowing oxidation/reduction at much lower potential. Due to the fact that the reactant remains at the WE surface or a metal oxide layer is formed the electrode is deactivated and needs a pulsed potential to continuously clean and regenerate an oxide-free metal surface for the reaction.

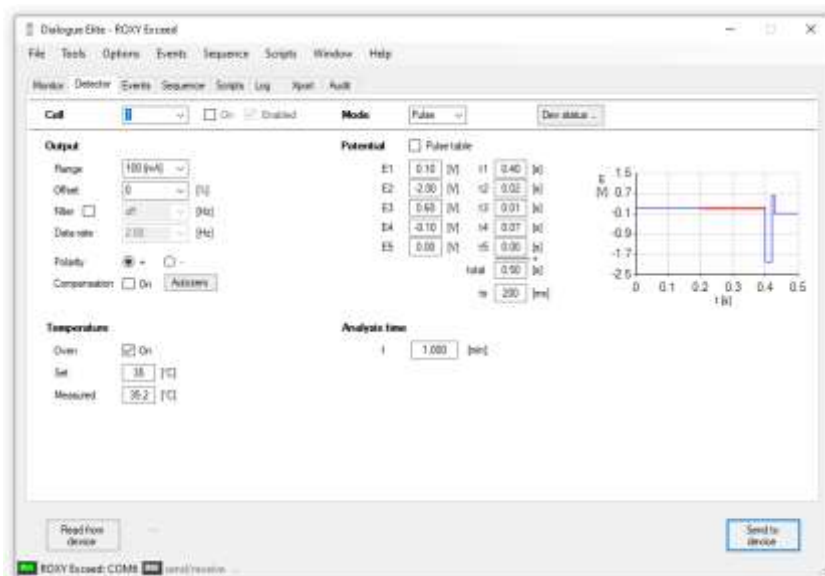

Fig. 23. Pulse mode method settings window in Dialogue Elite. The potential waveform settings are shown on the right side.

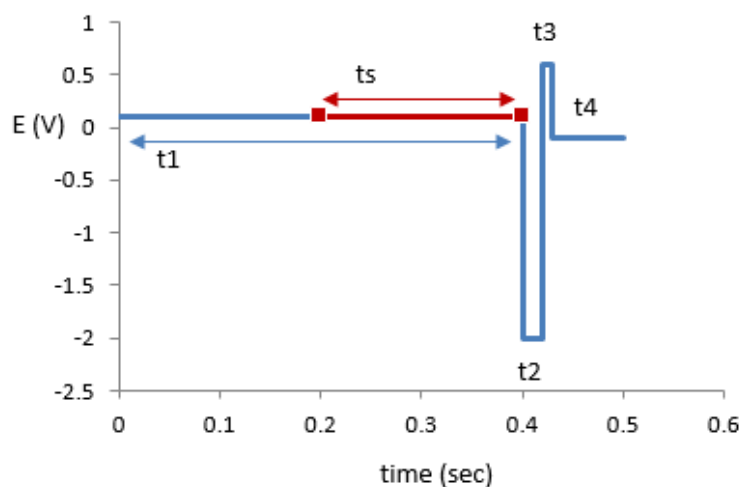

Fig. 24. Potential steps in pulse mode. During t_1 the measurement potential is applied, the actual current measurement occurs during t_s . Steps t_2 , t_3 and t_4 are for regenerating the electrode. This process repeats itself continuously as soon as the cell is on.

In pulse mode up to five potential steps can be defined. The sampling interval (period at which the current is measured) is applied at the end of E1.

Pulse mode - 2

In the ROXY Exceed an extended pulse mode, pulse mode - 2, is available when operating the instrument via a PC using Dialogue Elite or Chromeleon CDS software. The pulse mode - 2 is not available in manual operation using keyboard/display. In the extended pulse mode it is possible to program a multi-step waveform, with up to 30 time, potential (t,E) coordinates, see figure below. Furthermore, the measurement time interval in which the current is measured, marked by a 'Begin' and 'End' marker, is free programmable in the pulse table.

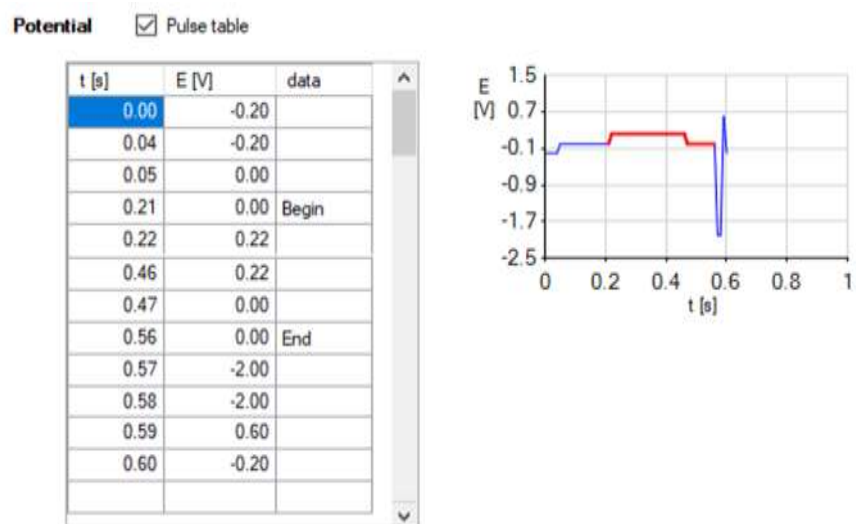

Fig. 25. The new pulse mode - 2 with freely programmable t, E table. In red the sampling of data for acquisition.



In Pulse mode - 2 the ADF filter settings 0.005, 0.002 and 0.001 Hz cannot be used.

Scan mode

See next chapter describing the optimization of the working potential.

CHAPTER 7

Optimization of working potential

Introduction

A current - voltage (I/E) relationship, or voltammogram, characterizes the REDOX behavior of an electrochemically active target compound. It gives information on the optimum oxidation/reduction potential, which can be used to improve the products formation (yield & selectivity) of electrochemical reactions. There are several ways to obtain the I/E relationship using the ROXY potentiostat:

A *hydrodynamic* voltammogram can be acquired using an EC flow cell and ROXY potentiostat coupled to an (U)HPLC system with MS. The voltammogram is obtained in the DC mode by running several chromatograms at different working potentials and measuring the EC current signal and mass spectra. A hydrodynamic voltammogram has as an advantage that the I/E relationship of all target compounds and the structure of the formed reaction products can be obtained simultaneously in one set of experiments (boundary condition: all target compounds and reaction products should be sufficiently separated under the applied LC conditions).

A *scanning* voltammogram is obtained in the so-called scan mode of the ROXY Potentiostat: in the scan mode the cell potential is swept between two pre-set values (E1 and E2) using a certain scan speed (in mV/s and the current is measured during the sweep. This method can be used to study the REDOX behavior of a pure target compound dissolved in a suitable mobile phase.

Hydrodynamic and scanning voltammetry are common methods to obtain the optimized potential for a target compound in EC/LC/MS or EC/MS when a mass spectrometer is used as a detector. A MS Voltammogram can be obtained also in DC mode by ramping the WE electrode potential within required range. All operational modes of the ROXY Potentiostat are programmable in the Dialogue (events table). A MS voltammogram can be visualized in a 3-D or 2-D plots. Information about MS voltammogram acquisition can be found in the Dialogue for ROXY™ EC system user guide (p/n 210.7017). Optimization of the working potential and the construction of a hydrodynamic and scanning voltammogram using ROXY Potentiostat keyboard are described in the next section

Electrochemical reactions

In an electrochemical reactor a reaction of the analyte at an electrode surface occurs. For electrochemically active compounds, the potential between reference electrode (REF) and working electrode (WE) determines the reactivity of the analyte at the WE. The potential difference supplies the energy level needed to initiate or enhance the electrochemical reaction. Different analytes may have different oxidation or reduction potentials.

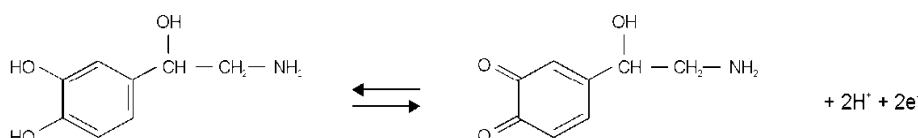

Fig. 26. Oxidation/reduction reaction of norepinephrine.

An example of an electrochemical reaction is shown in Fig. 26, norepinephrine is converted into a quinone by oxidation at the WE. Two electrons are transferred at the WE resulting in an electrical current that is amplified by the controller.

The mechanism of the REDOX reactions is the same for the ROXY applications. The potential is the reactions driving force, but the mass spectrometry (MS) is applied for the oxidation or reduction products detection. An example of an electrochemical reaction is shown in Fig. 26, norepinephrine is converted into a quinone by oxidation at the WE. Two electrons are transferred at the WE resulting in an electrical current that is amplified by the controller. The norepinephrine and its quinone product itself will be detected in mass spectrometer in ROXY applications.



Because of the same nature of electrochemical reactions in electrochemical detection and ROXY applications with MS detection some details that are strictly related to the electrochemical detection are presented in the following paragraphs. The purpose of these fragments is to explain the processes occurring in the electrochemical cell.

Hydrodynamic and scanning voltammogram

Hydrodynamic voltammogram

A hydrodynamic voltammogram is constructed when the pure analyte is not available and separation over an analytical column is required. Simply, the analyte is separated over the column and detected in the electrochemical cell with different potentials applied. To construct hydrodynamic voltammogram the peak heights are plotted vs. the potential (Fig. 26). Furthermore, under real chromatographic conditions reliable information about the S/N ratio is obtained.

Additionally, the hydrodynamic voltammogram can be used to optimize potential when ROXY EC/LC system is used. The drug compound /xenobiotic is oxidized in the electrochemical cell to the appropriate metabolites/oxidation products, prior to the injection into the HPLC and the metabolites are detected in MS. When mass spectrometer is used as detector, the extracted ion chromatogram (EIC) representing m/z ratios (mass to charge) of specific metabolites will be plotted and the optimal potential can be estimated.

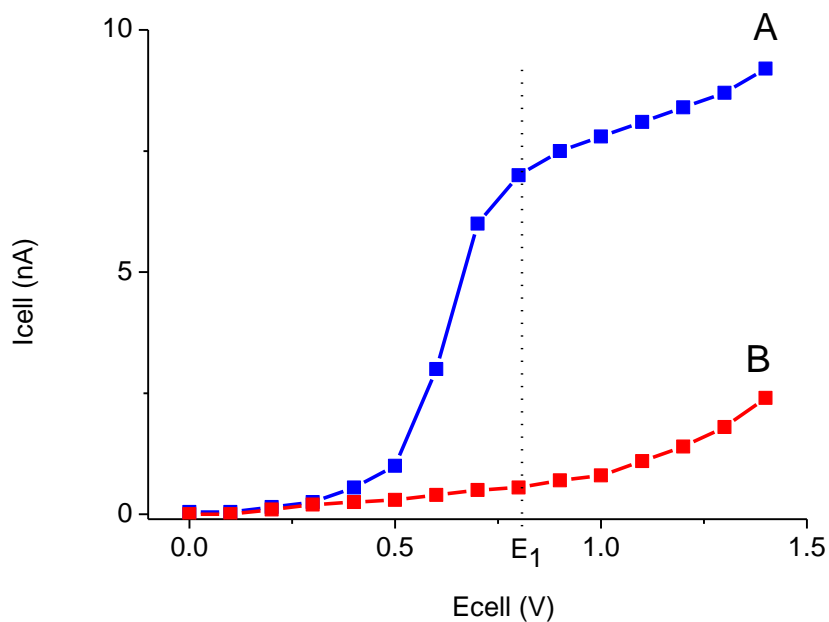

Fig. 27. Hydrodynamic voltammogram of norepinephrine (A) at a glassy carbon working electrode, and the current of the baseline (B). At E_1 the electrochemical signal becomes diffusion limited.

Scanning voltammogram

An alternative for the chromatographic construction of an I/E relationship is the application of scanning voltammetry (ROXY Exceed only). In a scanning voltammetry experiment the working electrode potential is ramped up and down between two preset potentials (E1 and E2) and the current is measured while the analyte is continuously flushed through the flow cell. This is repeated as many times as desired. The rate of voltage change over time is defined as the scan rate (mV/s).

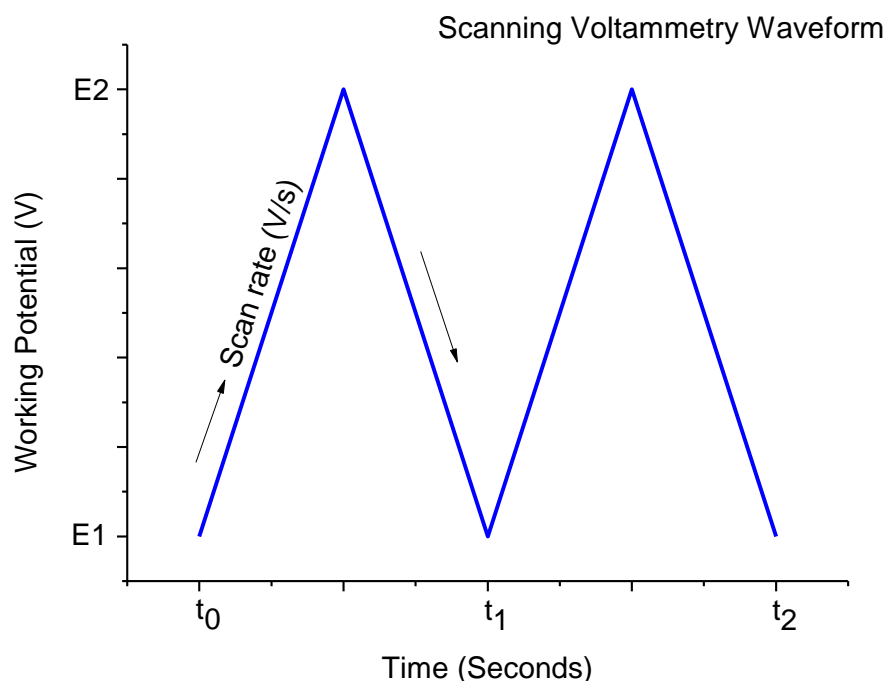

Fig. 28. Scanning voltammetry potential waveform.

The current is plotted against the working potential to give a voltammogram (I/E curve). An example is shown in Fig. 29. A difference with a hydrodynamic is that in scanning voltammetry, no HPLC separation is involved. The signal is the sum of all EC active substances. It takes only a few minutes to construct a *scanning* voltammogram. This is an advantage, especially when a number of analytes have to be characterized. However, it is a prerequisite to have the *pure* analyte dissolved in buffer. A scan of the buffer (blank) should be used to distinguish between solvent peaks and analyte peaks.



Any contamination in the buffer may lead to artefacts.

As can be seen in both Fig. 27 and Fig. 29, when the working potential is increased the electrochemical reaction is enhanced hence the signal increases. At a certain potential the I/E curve flattens. All analyte molecules that reach the working electrode are converted at such a high rate that the analyte supply becomes the limiting factor. At the working electrode surface a stagnant double layer exists, where molecular transport takes place by diffusion only. Therefore, the current at (and beyond) this potential is called the *diffusion limited current*.

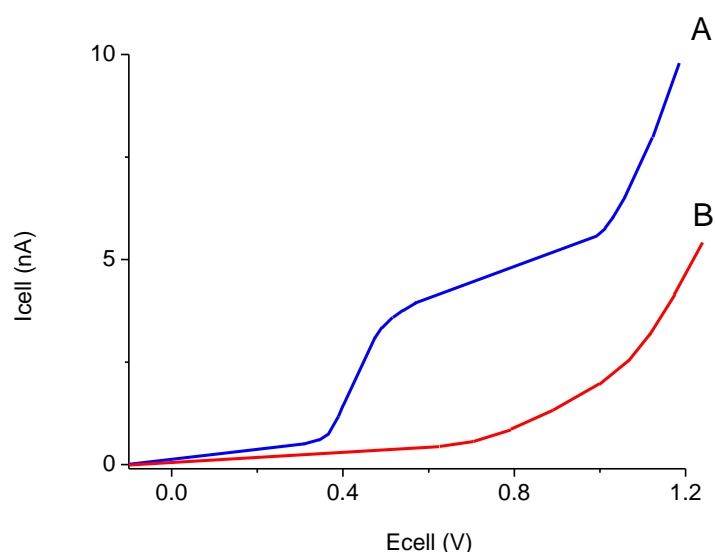

Fig. 29. Scanning voltammetry of 1.0 $\mu\text{mol/L}$ norepinephrine (A) at a glassy carbon working electrode, at a scan speed of 10 mV/s. Scan (B) is the blank solvent.

In practice the choice of the working potential is a compromise between sensitivity, selectivity and reproducibility or the yield in desired metabolite formation (in ROXY Ec applications). In the example of Fig. 27 a working potential (E_1) of 0.8 V is chosen.

Scanning voltammetry can be also used in ROXY EC applications. With MS detection the I/E curves can be used only as supplementary data. Mass spectrometry allows the sample identification (determining the elemental composition, structure elucidation) and all ions having specific m/z ratios are plotted in the mass spectrum. Mass spectrometry data can be presented in form of mass chromatogram, e.g., the extracted ion chromatogram (EIC) in which a specific metabolites/oxidation products are monitored throughout the entire run, and a particular analyte's mass-to-charge ratios are plotted at every point during the analysis. The optimal potential can be estimated from EIC plots. With help of the Fig. 29, where EICs are presented, it is easy to estimate the potential range in which the desired metabolite will have the highest abundance. E.g., for metabolite at m/z 354 the best will be potential 300-400 mV, however to form the metabolites 326 and 299 the higher value of potential (1200 mV) should be applied. In figure 17 the different mass spectra represents the different conditions: no potential, 300 mV or 1200 mV, respectively. The mass spectra corresponds to the scanning voltammogram presented in the figure 17.

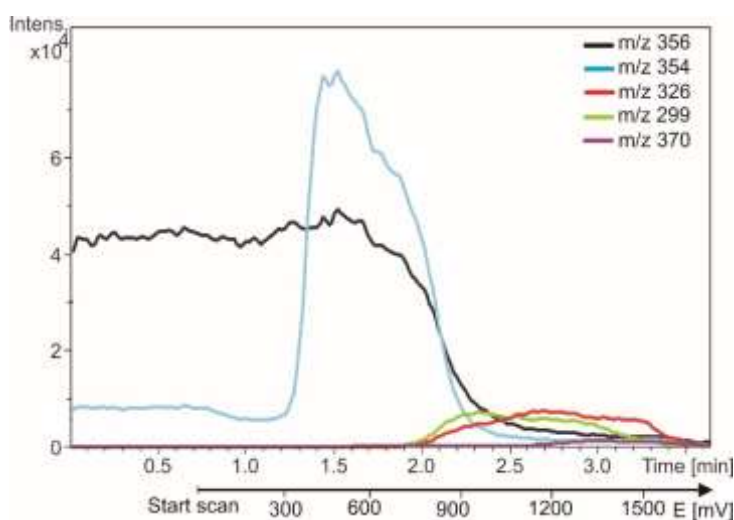

Fig. 30. Scanning voltammetry of 10 $\mu\text{mol/L}$ amodiaquine at a glassy carbon working electrode, at a scan speed of 10 mV/s. The m/z ratios of different metabolites of Amodiaquine are plotted (see legend).

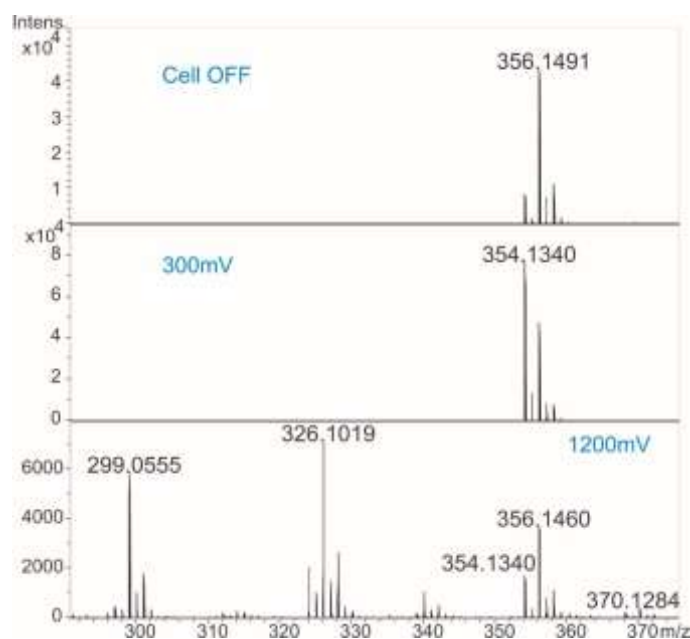

Fig. 31. Example of the mass spectra of 10 $\mu\text{mol/L}$ amodiaquine oxidized at a glassy carbon working electrode, at a scan speed of 10 mV/s.

Optimization using a voltammogram

Sometimes, when interfering peaks appear in the chromatogram, it is possible to optimize the method with regard to selectivity. If the interfering compound has a higher oxidation potential, a working potential is chosen that gives the best selectivity, i.e. the largest difference in peak height. In the example of Fig. 32 the selectivity for compound X is improved considerably by decreasing the potential to E_2 or E_1 . Obviously, if compound Y is the compound of interest, optimization of selectivity in this way is not possible and the chromatography has to be optimized.

Electrochemical detection differs from most other LC detection methods in that a reaction takes place in the detection cell. Due to reaction kinetics an increased temperature speeds up the oxidation/reduction reaction. However, this not only holds for the analyte but also for the background current and possible interferences. An elevated temperature will therefore not au-

tomatically lead to a better detection. A *constant* temperature is of paramount importance for a stable baseline and reproducible detection conditions.

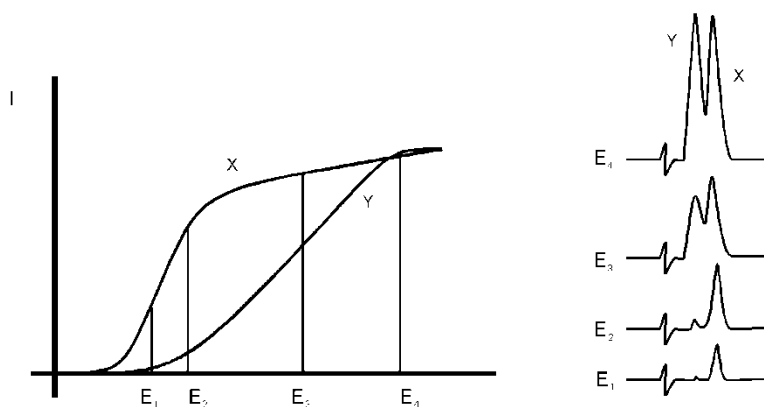

Fig. 32. Selectivity in LC-EC of compound X and Y is optimized by choosing the working potential with the largest difference in peak height.

Electrochemical reactions are pH sensitive (Fig. 33). For norepinephrine the I/E curve is shifted to a lower potential at higher pH. When the working potential is high (E_2), and the signal is diffusion limited, an increase in pH will result only in a small increase of the peak height. When the working potential is lower (E_1), and the signal is not diffusion limited, the signal will strongly increase at higher pH. In both cases the background current increases at a higher pH.

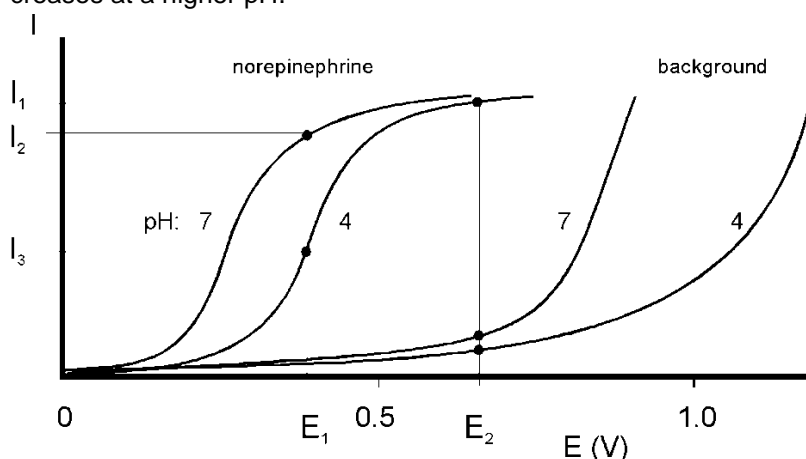

Fig. 33. At a higher pH the I/E curve of norepinephrine is shifted to the left.

Reaction kinetics predict that electrochemical detection is mass flow dependent. When the LC flow is stopped in LC-EC, the analyte will be oxidized completely and the signal decreases rapidly. This means that the

flow rate not only affects temporal peak width and analysis time but also peak height. Also the background signal is sensitive towards fluctuations in the flow rate. Therefore, it is important to use a pulse-free solvent delivery system.

Construction of a hydrodynamic voltammogram

Before a hydrodynamic voltammogram can be obtained, the chromatographic conditions should be optimized. Then the following steps are taken:

1. A solution of the analyte at a concentration between 1 - 100 $\mu\text{mol/L}$, is prepared in mobile phase.
2. The electrochemical potentiostat is stabilized in the DC mode at a high potential. After stabilization the background current is read from the display of the potentiostat (I-cell) and the noise is measured.
3. The run is started by injecting the compound. When at the high working potential no signal is obtained, it may be concluded that the compound is not electrochemically active. In such a case derivatization of the compound may be an option.
4. If a peak is measured, the working potential is decreased by 50 or 100 mV and step 2 to 4 is repeated until the lowest potential setting (Fig. 34).
5. The peak heights and the background currents are plotted against the working potential (Fig. 27).

The working potential which gives the best sensitivity is obtained by plotting the signal-to-noise ratio against the working potential.

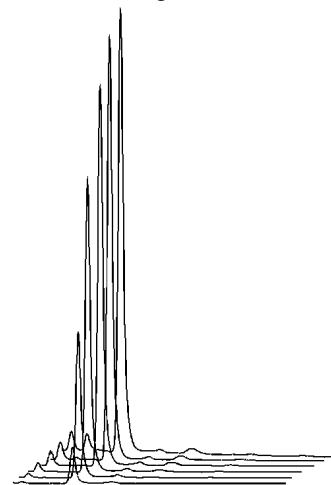

Fig. 34. Construction of a hydrodynamic voltammogram for nor-epinephrine. Chromatograms are obtained at cell potentials ranging from 1.0 V (back) to 0.4 V (front), with 100 mV steps.

Construction of a scanning voltammogram

A scanning voltammogram can be recorded using the ROXY Exceed scan mode. The scan mode is programmed in the 'SCAN SETUP' screen of the ROXY Exceed. Depending on the data acquisition software that is used and the experimental set-up, a full, half or continuous scan cycle can be chosen.

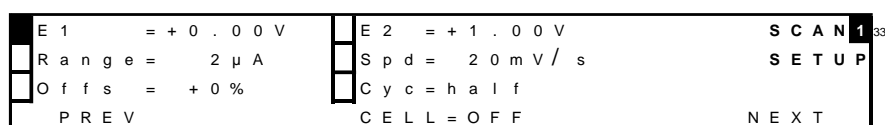

Fig. 35. Programming the scan mode in the 'SCAN SETUP' screen.

With the Dialogue Elite control software a scanning voltammogram can be programmed under the 'Potentiostat' tab in the main window.

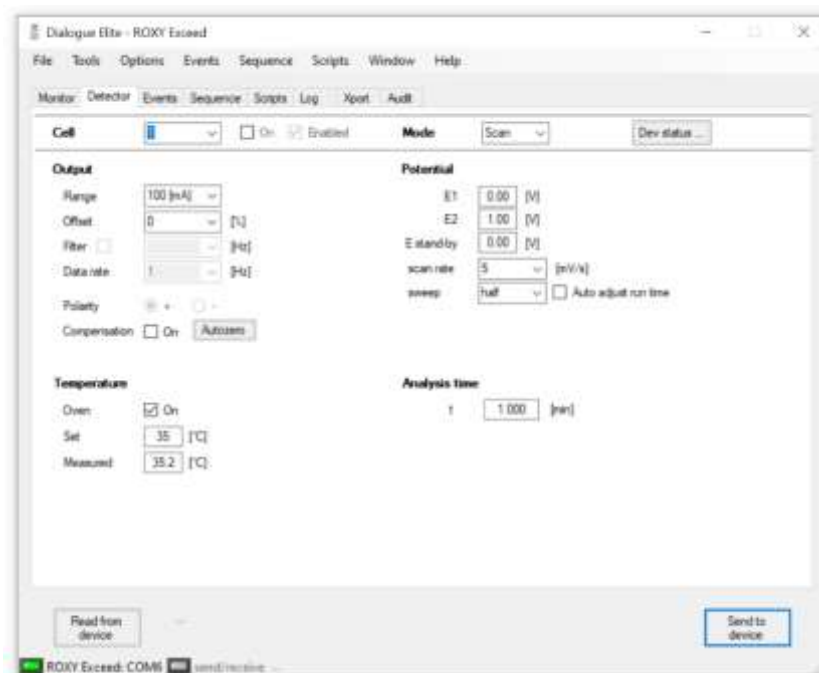

Fig. 36. Programming a scan in the Dialogue Elite software, half sweep.

In the above example a 'half' scan is programmed, sweeping the potential from 0 V to 1.0 V. A full scan would include the reverse scan, i.e. from 0 V to 1.0 V and back to 0 V.

In continuous mode the potential will be continuously swept between E1 and E2 until the predefined number of scans programmed are completed. Note that under Dialogue Elite control also a stand-by potential (E standby) can be programmed. This is the potential at which the cell be set before and after the scan experiment.

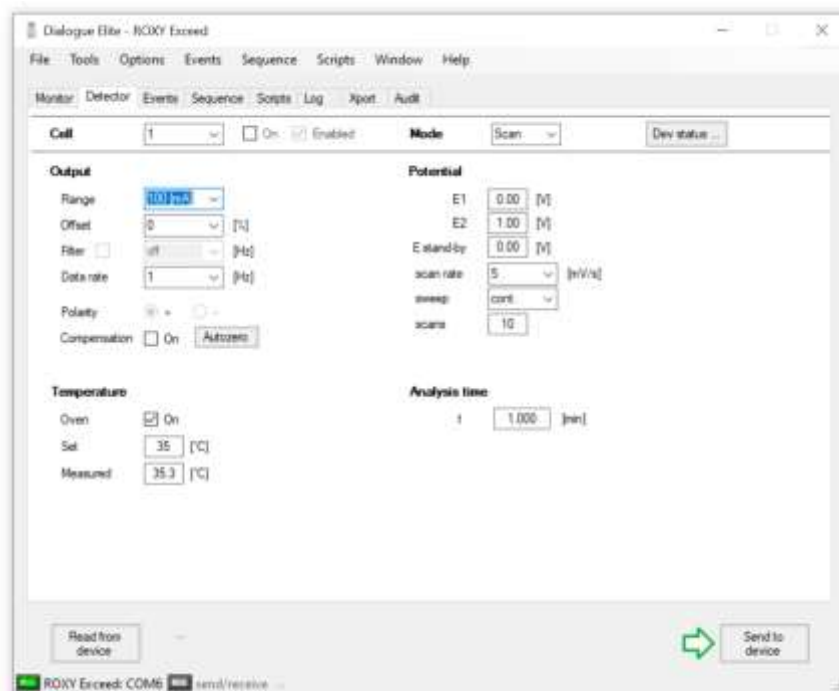

Fig. 37. Programming a scan in the Dialogue Elite software, continues sweep operation.

A convenient way to record a scanning voltammogram is by direct infusion of analyte in the flow cell using a syringe pump. In the figure below a scanning voltammetry set-up is shown.



Fig. 38. ROXY Exceed scanning voltammetry set-up with a syringe pump.

The Antec dual syringe infusion pumps (pn 188.0035, 36 and 37) which can be obtained as accessory has as an advantage that it can be controlled in Dialogue Elite software as well.

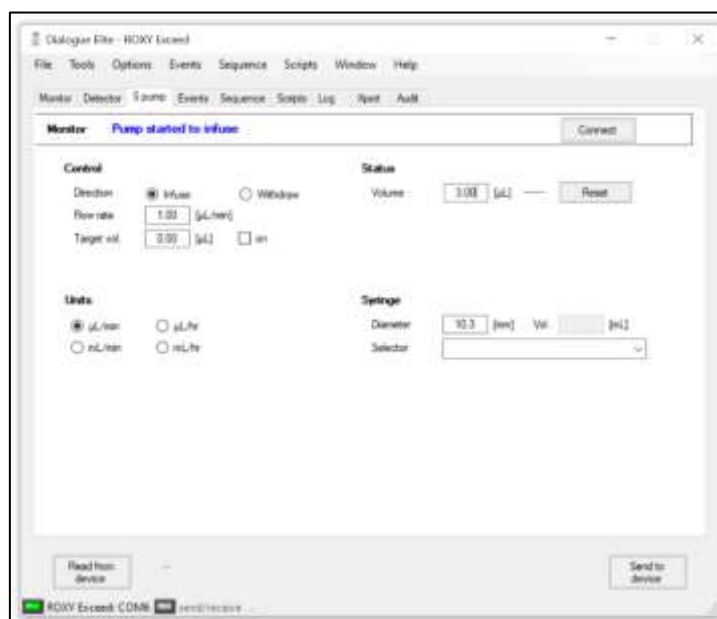

Fig. 39. Programming the Antec infusion pump in Dialogue Elite.

In the example below a half scan is shown at a flow rate of 10 $\mu\text{L}/\text{min}$ of a 20 μM Serotonin (5-HT) standard in mobile phase.

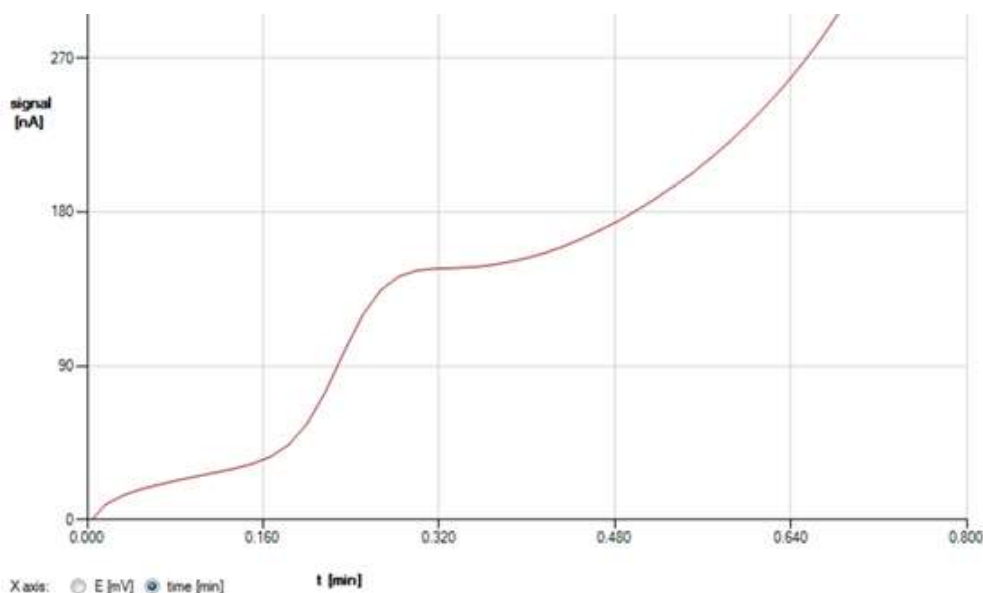

Fig. 40. Scan (cycle: half) of a 20 μM Serotonin in mobile phase at a glassy carbon working electrode. Scan speed 20 mV/s.

The following procedure is advised to record scanning voltammogram of analytes:

- Use a voltammetry set-up as shown in figure 48 (preferably) in combination with the Dialogue Elite software and a syringe pump for direct infusion of analyte in the flow cell.



If Dialogue is not used, connect an A/D converter to the analog output of the potentiostat to record the cell current. Set the A/D converter sampling rate to 1 Hz. This is the same frequency as the voltage steps during the scan. If a higher sampling frequency is chosen a typical stepwise pattern may appear. Note that with such set-up only 'I versus t' curves can be obtained.

- Prepare a solution of the pure compound dissolved in (preferably) the HPLC buffer with a concentration in the range of 10-100 μM .
- Set the lower (E1) and upper potential (E2), the scan rate (Spd), range and scan cycle in the 'SCAN SETUP' menu or under the

'potentiostat' tab in Dialogue.

Typical scan settings to start with: E1 0 mV, E2 1000 mV, scan speed 10 mV/s, range 5 μ A/V. Optimize the settings if required for your specific compounds.

- Prime a 1 mL glass syringe with analyte solution and install it in the syringe holder of the pump.
- Program the syringe diameter and flow rate in the syringe pump settings menu. In case a syringe pump is used which can be controlled in Dialogue the settings can be programmed under the 'S pump' tab. A typical flow rate to start with is 10 μ L/min. Optimize the flow rate if required during the scan experiments.
- Start the syringe pump and before scanning assure that the flow cell is sufficiently primed with analyte solution.
- A scan can be started (stand-alone) by pressing the 'START' button in the 'SCAN STAT' menu or by starting a single run in Dialogue: press the 'F5' button or click 'start single run' under the 'Options' menu.
- To record a background (blank) scan repeat the experiment with the pure HPLC buffer in which the analyte was dissolved.

When scanning with the Dialogue Elite software ('continuous') all scans are displayed and can be selected individually.

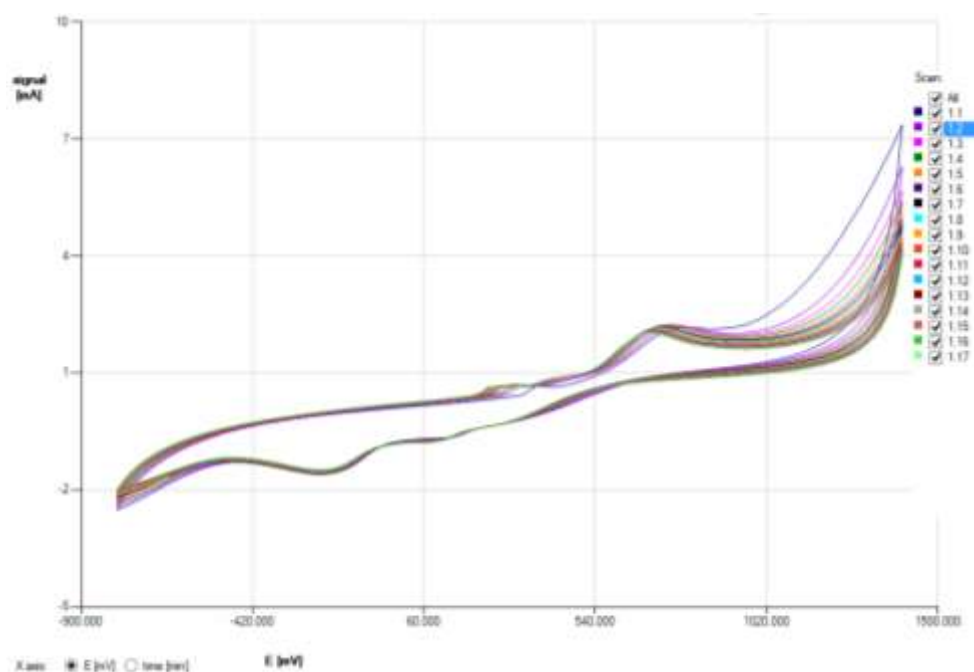

Fig. 41. Example of multiple scans ('continuous') of Amodiaquine.

On-line electrochemistry mass spectrometry



Information about potential optimization for ROXY EC system and the detailed background information about the supplied events files and relevant Dialogue settings are provided in the application note 210.001A ROXY™ EC system – events programming & settings

ROXY EC system delivers the oxidative metabolic fingerprint of the molecule in a very short time. The acquired mass spectra can be presented in three-dimensional plots, so-called MS voltammograms (Fig. 40). A MS voltammogram visualizes the ion abundance versus m/z as a function of applied potential to the electrochemical cell. With a mass voltammogram the optimal potential can be determined for electrochemical generation of the desired metabolite for further research, e.g., NMR.

In the figure 21, the 3-D MS voltammogram of amodiaquine is shown. To oxidized Amodiaquine to get dehydrogenated metabolite it is required to use lower (400mV) potential than to form to other metabolites (m/z 299 and 326) and in this case the potential should be ca. 1200mV. For each cell potential mass spectra are recorded and saved in separate data files.

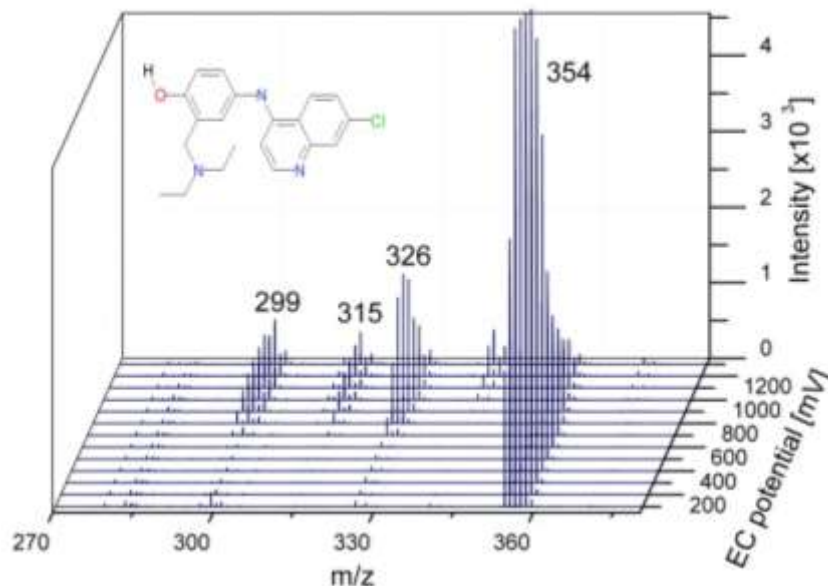

Fig. 42. 3-D MS Voltammogram of Amodiaquine. The plot is reconstructed from the separate mass spectra saved for each potential value.

Furthermore, the 2-D version of Voltammogram can be recorded and the data can be saved in one MS file, as presented in the figure 22. This plot can be quickly generated with any of MS software.

Both, 3-D and 2-D MS Voltammograms were acquired in the DC mode. The Dialogue controls the syringe pump, the potentiostat and triggers the acquisition of mass spectra at the designated cell potentials.

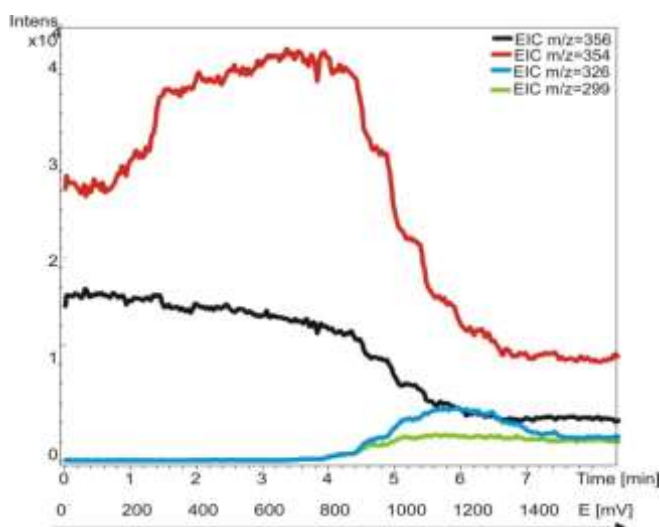

Fig. 43. 2-D MS Voltammogram of Amodiaquine. The mass spectra are saved in one file for whole analysis. EIC are representing the changes in oxidation of the Amodiaquine with respect to the potential applied.

CHAPTER 8

Specifications ROXY Exceed**Environmental, dimensions, weight & power requirements**

Working temperature	10 - 35°C (indoor use only)
Storage temperature	-25 - +50°C
Humidity	20 - 80% RH
Safety and EMC	CE, UL, CSA, CB Scheme
Equipment class	1
Installation category	II
Pollution degree	2
Dimensions	43 (D) x 22 (W) x 44 (H) cm = 16.9" (D) x 8.7" (W) x 17.3" (H)
Weight	14.4 kg (32 lbs) without flow cell and column (SSC version)
Installation	Install upright on flat & smooth surface, keep space under the potentiostat free.
Power requirements	100-240 VAC, 50/60 Hz, 260 VA, auto-sensing
Mains fuse	2.5 AT / 250V, 5x20 mm, IEC 60127-2 For safety reasons, any other internal fuse or circuit breaker is not operator accessible, and should be replaced only by Antec authorized personnel. Only use manufacturer-supplied fuses.



For optimum analytical performance it is recommended that the ambient temperature of the laboratory be between 20-25 °C and be held constant to within ± 2 °C throughout the entire working day. Note: that for optimal performance of the oven the oven temperature should be set at least 7 degrees higher as ambient temperature.

General

Operating modes	DC, PULSE, PULSE2, SCAN
Other mode	CONFIG, DIAG and SERVICE
Sensors	1 flow cell (SCC), up to max. of 2 (DCC)
Autozero	triggered by keyboard, rear panel TTL, or remote PC control (LAN)
Offset	+50% to - 50% of max. output voltage, 5% steps
PC control	Parametric control and data-acquisition via LAN port (USB service port)
Embedded software	Flash technology, upgradeable via PC (USB)
Oven	+7°C above ambient to 60°C, accuracy ±0.5°C, stability ±0.1°C; accommodates column and reactor cell(s)
Rear panel connectors	1x IEC inlet (Mains), 1x USB B, 1x RJ45 LAN, 1x 9-pins sub-D Male (Valve), 1x 9-pins sub-D Female (Analog output), 1x 25-pins sub-D Female (Digital I/O)
Analog output (DAC)	-1 to +1 V full scale (via 16-bit D/A converter)
Analog output (I/E)	-2.5 to +2.5 V full scale (unprocessed I/E converter signal)
Digital I/O (HW)	2x Relay, 5x TTL outputs (CMOS 3.3V logic), 13 TTL inputs (programmable), 1x GND
Programmable I/O functionality	Cell on, Cell off, Autozero, Start, Overload, Relay, Auxiliary
Valve control	VICI valco 2-pos electrically-actuated valve (E2CA, EHCA) via serial cable, Manual valve, 1x inject marker output

DC mode

Range	1 nA - 100 mA in 1, 2, 5 increments
Filter (ADF)	RAW (100 Hz), OFF (10Hz) , 10 - 0.001 Hz in 1, 2, 5 increments
Potential (Ec)	-4.90V to + 4.90V with 10 mV increments
Data Rate	1 - 100 Hz in 1, 2, 5 increments, dependent on filter setting
Noise	< 4 pA with dummy cell (load of 300 MΩ/470 pF) in 1 nA range, filter off, Ec +800mV and temperature of 35 °C.

PULSE mode

Range	200 nA - 100 mA in 1, 2, 5 increments
Filter (ADF)	0.5 - 0.001 Hz in 1, 2, 5 increments OFF: for unprocessed data
Potential (Ec)	-4.90V to + 4.90V with 10 mV increments
Data Rate	1/(pulse duration) Hz
Waveform	Max 5 potential steps
Pulse times (t1-t5)	t1: 100 ms - 2000 ms; t2, t3, t4, t5: 0 - 2000 ms in 10 ms increments
Sampling times (ts)	20 ms – [t1 – 60] ms

PULSE mode - 2 (available by PC control only)

Range	200 nA - 100 mA in 1, 2, 5 increments
Filter (ADF)	0.5 - 0.01 Hz in 1, 2, 5 increments OFF: for unprocessed data
Potential (Ec)	-4.90 V to + 4.90 V with 10 mV increments
Data Rate	1/(pulse duration) Hz
Waveform	Free programmable multi-step waveform with up to 30 time-potential (t, E) coordinates and max. pulse duration of 4 s. Time points in 10 ms increments.
Sampling time	Sampling interval is free programmable, defined by a 'Begin' and 'End' marker

SCAN mode

Range	200 nA - 100 mA in 1, 2, 5 increments
Potential (Ec)	-4.90 V to + 4.90V with 10 mV increments
Data Rate	1 Hz
Scan rate	1 - 100 mV/s in 1, 2, 5 increments
Cycle	Half, Full, Continuous

Electrochemical cells

For the ROXY Exceed potentiostat a series of reactor cells are available. Cells need to be ordered separately and are not part of a ROXY potentiostat. Only in case of purchase of a complete ROXY EC system a suitable cell is delivered with the shipment. For detailed information about the different flow cells please refer to the reactor cell user manual.

ReactorCell™

Type	Thin-layer flow-through reactor cell
Spacers	50 μm or 130 μm
WE diameters	8 mm disc
Cell volume	Approximately 0.75 μl (with 50 μm spacer)
WE electrodes	Glassy carbon (GC), Boron Doped Diamond (BDD), gold (Au), platinum (Pt), Optional: silver (Ag) and copper (Cu)
Reference electrode	HyREF™ (Pd/H ₂)
Auxiliary electrode	Carbon-filled PTFE
Wetted materials	PCTFE, Palladium, FEP, Carbon-filled PTFE, WE material (GC, Ag, BDD, Pt etc.)
Max. pressure	40 psi / 2.8 bar



μ-PrepCell 2.0™

Type	Thin-layer electrochemical cell (micro-preparative work)
Spacers	50 or 100 μm, stainless steel, stackable (max. stack thickness 250 μm)
WE dimensions	12 x 30 mm, thickness 1 mm
WE area (wetted)	1.9 cm ²
Cell volume	10 μl (effective spacer thickness 50 μm)
Working electrode	Glassy Carbon (GC), Boron-Doped Diamond (BDD), Platinum (Pt) and Gold (Au)
Reference electrode	HyREF™ (Pd/H ₂ electrode)
Auxiliary electrode	Conductive PEEK (PEEK, 30% carbon fiber-reinforced)
Wetted materials	PEEK, Carbon, Methyl-vinyl silicone rubber (Silicone VMQ-70), PCTFE and WE material (see working electrode section)
Fluidic connections	1/16" OD PEEK or PEEKsil tubing, ID 250 μm or less, with 10-32 PEEK fingertight fitting
Electrical connections	ROXY cell cable incl 0.5uF, 3m (part 250.0139L)
Flow rate	Typically 20 – 100 μL/min
Working temp range	10 - 50 °C
Max. pressure	25 bar (GC electrode) , 50 bar (with MD electrode)



μ-PrepCell SS™

Type	Thin-layer electrochemical cell for disulfide bridge reduction in peptides & proteins
Spacers	50 or 100 μm, stainless steel, stackable (max. stack thickness 200 μm)
WE dimensions	12 x 30 mm, thickness 1 mm
WE area (wetted)	1.9 cm ²
Cell volume	10 μl (effective spacer thickness 50 μm)
Counter electrode	Platinum (Pt)
Inlet block (WE)	Titanium (Ti)
Wetted materials	Titanium, Platinum, Methyl vinyl silicone rubber (Silicone VMQ-70) or PTFE, PEEK
Fluidic connections	1/16" OD PEEK or PEEKsil tubing, ID 250 μm or less, with 10-32 PCTFE fingertight fitting
Electrical connections	ROXY cell cable, 2 electrode config, 3m (pn 250.0139D)
Flow rate	Typically 20 – 100 μL/min
Working temp range	0 - 50°C
Max. pressure	80 bar (Silicon O-ring), 350 bar (PTFE O-ring)



SynthesisCell™

Type	Batch reactor cell for electrochemical synthesis
Cell volume	Up to 80 mL of sample solution in glass reaction vessel <i>Optional: Water-jacketed reaction vessel (for cooling exothermic reactions)</i>
Working electrode	Tubular Reticulated Glassy Carbon (RGC) <i>Optional: Flat Smooth Boron-Doped Diamond (BDD) and Tubular Mesh Platinum (PT)</i>
Reference electrode	HyREF™ (Pd/H ₂ electrode) <i>Optional: Ag/AgCl reference electrode</i>
Auxiliary electrode	Coiled platinum wire in glass isolation tube
Wetted materials	PEEK, Carbon, Methyl-vinyl silicone rubber (Silicone VMQ-70), PCTFE and WE material (see working electrode section)
Port plug	Access port for sample collection, dispensing of reagents, or venting of cell
Electrical connections	ROXY cell cable incl 0.5uF, 3m (part 250.0139L)



CHAPTER 9

Rear panel I/O

In this chapter all rear panel functionality is described. The ROXY Exceed has besides the mains inlet in total 5 connectors on the rear panel for communication, data output and I/O. A photo of the rear panel connectors is shown below for reference.

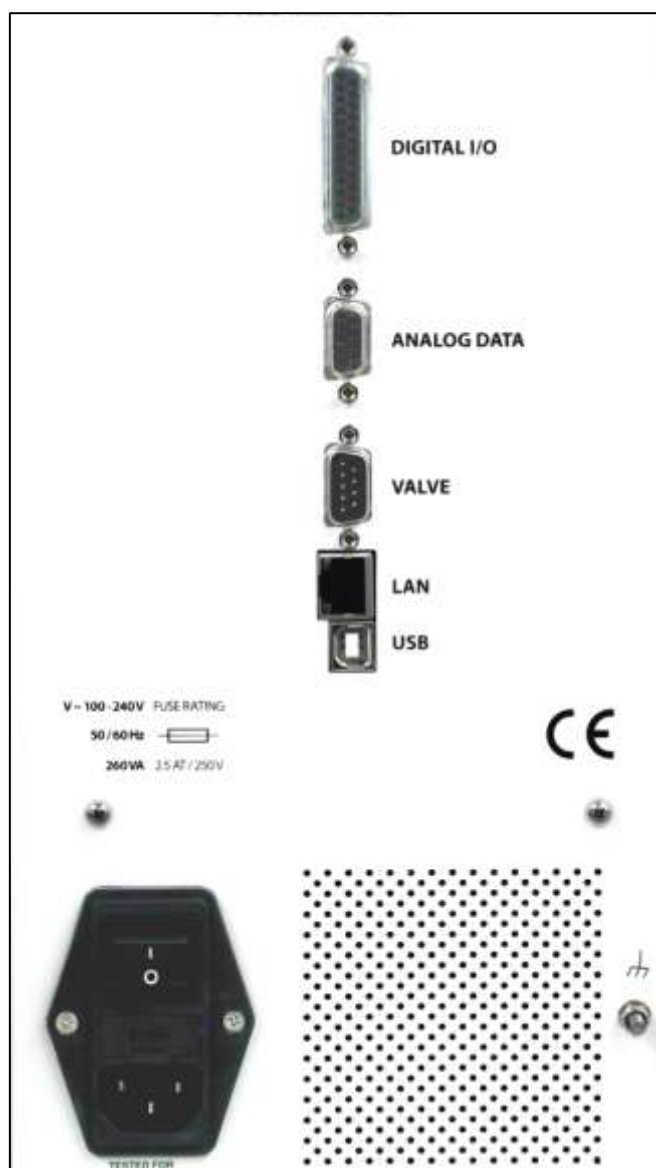

Fig. 44. ROXY Exceed rear panel.

USB B connector

USB type B connector for serial instrument control over USB, for service use only:

- Based on USB-to-serial UART interface using the FT232R chip from FTDI (Future Technology Devices International Ltd).
- FT232R is fully compliant with USB 2.0 specifications.
- Fixed communication baud rate: 921600 bps.
- Communication over USB is used for software (FW) update of the instrument only using Antec boot loader FW upload utility.

LAN connector

RJ-45 bus for serial instrument control over LAN:

- 10Base-T or 100Base-TX (Auto-Sensing) serial-to-ethernet connectivity.
- Network configuration of Xport via Lantronix device installer software utility.
- Fixed communication baud rate: 921600 bps
- Communication over LAN is used for parametric instrument control and data-acquisition.



To establish communication over LAN, the LAN cable must be connected when starting the potentiostat using the mains power switch on the rear panel. If no or both communication cables (LAN and USB) is connected during start-up, communication via USB is enabled (default).

Please consult the installation section for details about configuration and set-up of communication over LAN.

VALVE connector

Serial D9 (9-pins subD male) valve control connector for electrical (Vici) and manual valves:

- Serial (RS232) valve control of Vici 2-position electrically actuated valves via pin 1 - 3 (see Vici technical note tn413.pdf on the official www.vici.com web site). Compatible with the E2CA and EHCA actuator control module.

- Automatic detection of electrically actuated Vici valve, valve control in: STAT screen and Command ID 30 (0=load, 1=inject).
- Manual valve status (load/inj) read-out via pin 5 and 6 (contact closure).
- Inject Marker (pin 9) TTL output. Default: high 3.3V (load), on inject event: low (0 V) for 2000 ms.

Valve connector layout

In the table below the connector layout is shown for the Valve connector.

Table V. Valve connector lay-out.

Pin	Layout
1	GND
2	TRANSMIT(TxD)
3	RECEIVE (RxD)
4	-
5	GND
6	SWITCH (Hand valve)
7	-
8	-
9	INJECT MARKER

For a manual valve the status (LOAD/INJ) read-out is established by connecting the LOAD/INJ sensor wires/leads of a manual valve to pin 5 and 6 (contact closure).

Inject marker

A connected valve enables the inject marker (pin 9)]. The contact is high when the valve is in 'load' position (3.3V), and low (0V) in the 'inject' position. On an inject event the contact will go to 0V (low) for 2000 ms, It can for example be used to start the integration software when injection is done.

Electrical valve configuration

A Vici electrically-actuated 2-position valve is automatically detected during start-up of the instrument. Automatically the Valve parameter in the ROXY Exceed IO menu is set to Valve = Present.

Temp = 35° C	Contrast = 20	CONFIG
Valve = Present	Vout source = DAC	
	ID1 master = no	
PREV	IO	



Always restart the potentiostat (by re-powering via the mains switch on the rear panel) when connecting the valve for correct initialization of an electrically-actuated Vici valve.

In the case an electrical Vici valve is detected, the Dialogue Elite software automatically shows the presence of the electrical valve in the device settings window (EC device) and valve control buttons will appear in the potentiostat window.

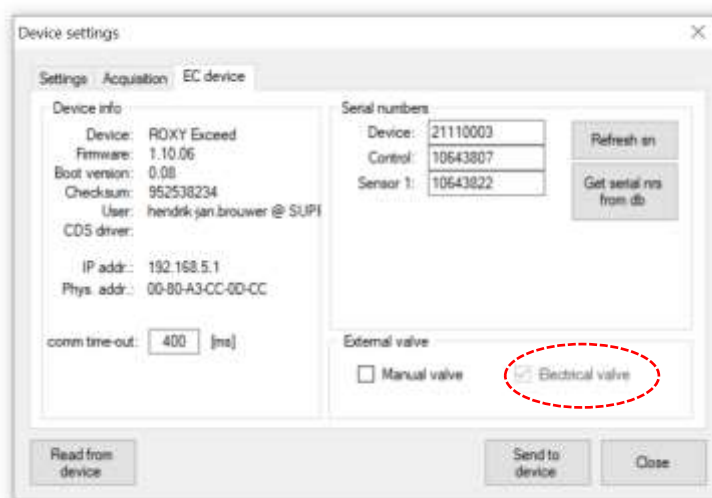

Fig. 45. Dialogue Elite device settings window.

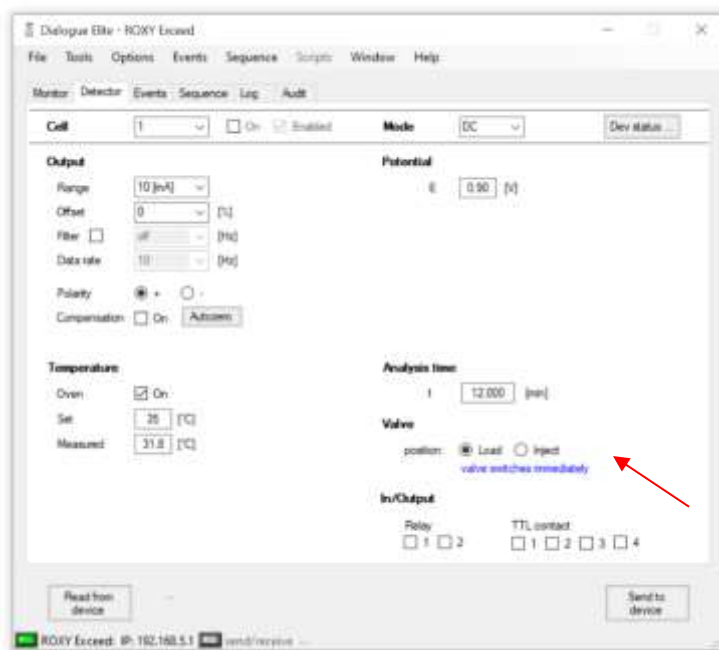

Fig. 46. ROXY Exceed potentiostat window with Valve control.

Manual valve configuration

In case of a manual Valve the valve present parameter has to be set manually. Configuration of a manual valve can be done via the LCD screen or the Dialogue Elite software.

LCD display: Configuration of a manual valve can be done by setting the Valve parameter in the IO menu manually to Valve = 'Present'.

Dialogue Elite: Go to the device settings and the EC device tab and check the manual valve check box.

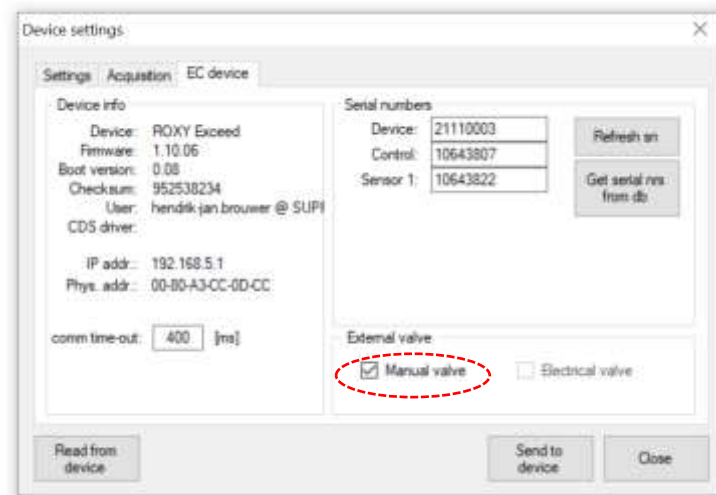

Fig. 47. Dialogue Elite device settings, manual valve check box.

Valve status & control

In stand-alone mode (Exceed only) the valve status for both an electrically-actuated valve and manual valve is displayed in the STAT screens on the LCD display. For example see the screen dumps of the STAT screen for a ROXY Exceed SCC (top) and DCC potentiostat. INJ=L represents the LOAD position (position A on the actuator control module of an electrically-actuated valve) and INJ=I represents the INJECT position (B on the actuator control module). The LOAD position is the default position at start-up of the instrument in the case of an electrically-actuated valve.

```

Vout = +0.057 V      Ic = +23.45 nA      DC 1
Range = 50 nA       Ec = +0.50 V      STAT
Filt = .002 Hz     Comp = off 25 > 30 °C 211.20
PREV CELL=ON      MARK AZERO INJ=L
  
```



In stand-alone mode the valve position can be controlled via the F5 function button in the STAT screen. In the case of a manual valve the information above the F5 button (INJ=L) in the STAT screen shows the status (position) of the valve only, no valve control is possible with this type of valve.



Make sure that the valve flow path is connected correctly and LOAD corresponds with position A and INJECT with position B. See example in the figure below for a 6-port valve.

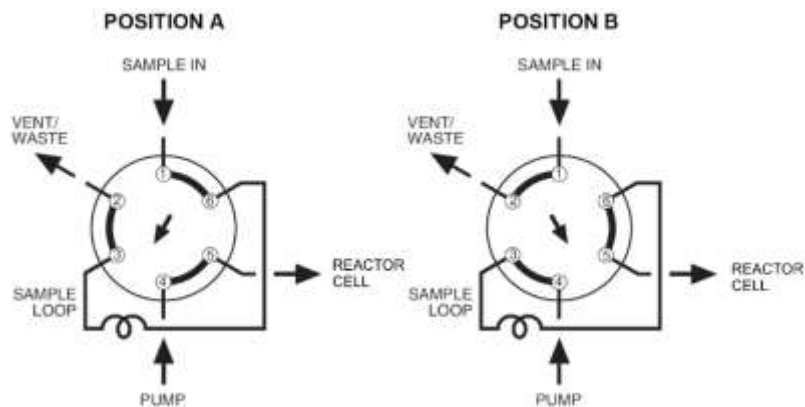

Fig. 48. Example of the valve flow path of a 6-port valve.

In Dialogue Elite the valve status/position is shown under the monitor tab. To make it visible in the left table, check the valve position checkbox in the item selector (by default the valve position is not show).

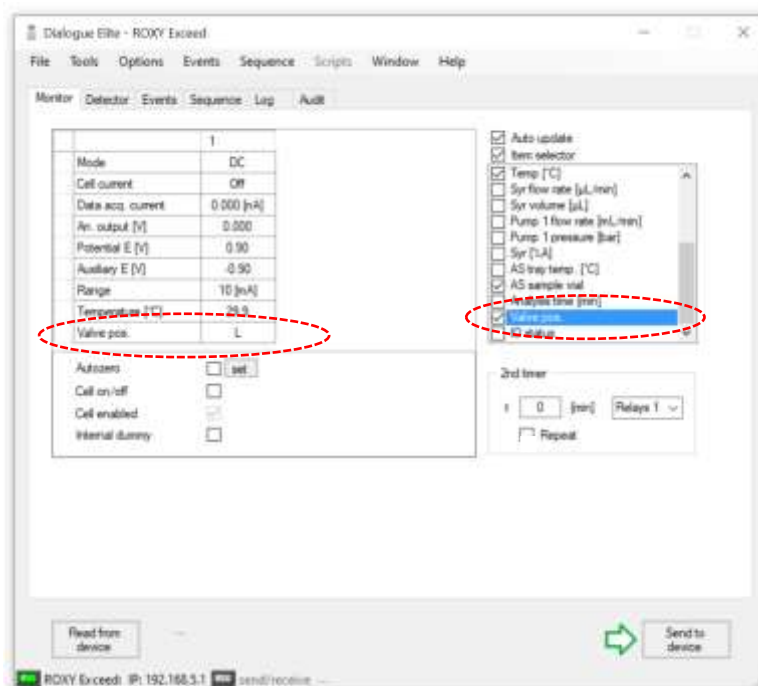

Fig. 49. Dialogue Elite Monitor tab with valve status (position) displayed.

An electrically-actuated VICI valve can also be controlled via Dialogue Exceed under the potentiostat tab, see figure 47. Note that the valve will switch immediately after a change from Load to Inject (checkboxes) or vice versa, no 'Send to device' action is required.

An electrically-actuated VICI valve can also be controlled via timed events under the events tab in Dialogue Exceed. In the Event editor the event 'valve position' is available to switch the valve in the Load/inject position. See example below in the figure on the next page.

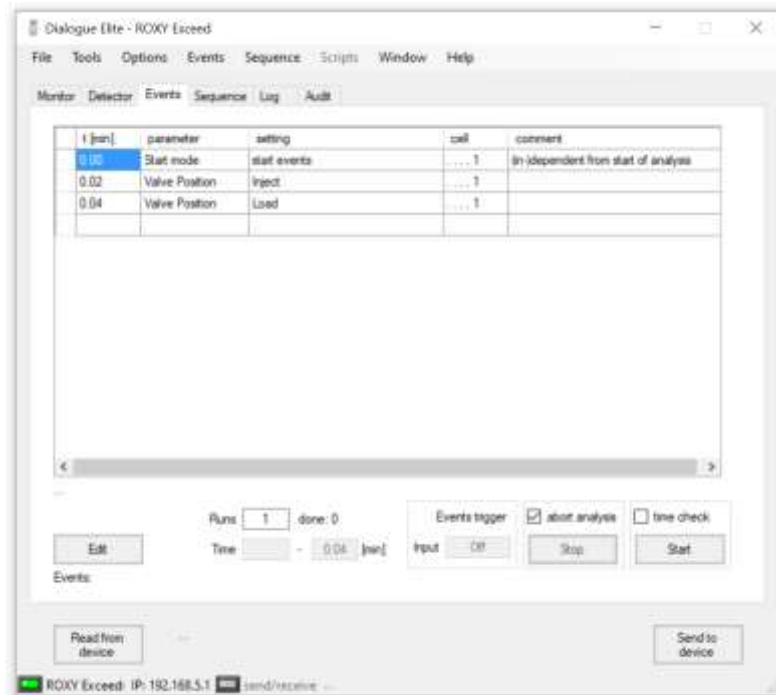

Fig. 50. Dialogue Elite Events tab with an example of two programmed events switching the valve to Inject ($t = 0.02$ min) and back to Load ($t = 0.04$ min).

ANALOG DATA connector

The ROXY Exceed is equipped with an analog data output connector to provide the measured signals in millivolts (mV) for users who work stand-alone without PC control with the instrument. The ANALOG DATA connector (D9-female) can either be connected to an X-Y recorder or A/D converter. The ANALOG DATA output can supply either a non-manipulated signal directly from the I/E converter, or the processed data signal by the CPU of the ROXY Exceed. The type of output can be selected from the CONFIG screen by setting the parameter Vout source to either DAC or I/E (ROXY Exceed only, for Exceed use Dialogue Exceed to set value).

Temp = 35° C	Contrast = 20	CONFIG
Valve = Present	Vout source = DAC	
	ID1 master = no	
PREV	I O	

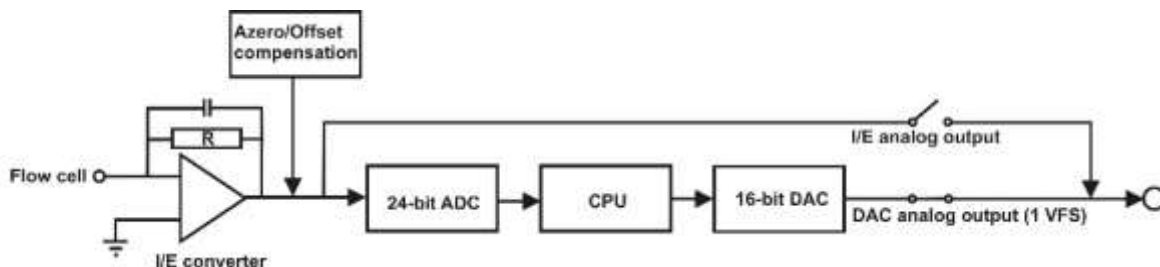

Fig. 51. Top: CONFIG screen. Bottom: ROXY Exceed signal processing from electrochemical flow cell to output. R is a selectable I/E resistor of $100M\Omega$, $10M\Omega$, $100K\Omega$, $1K\Omega$, 100Ω and 10Ω in the I/E converter circuit.

The output parameter V_{out} source can also be selected/set using Dialogue Exceed. Go to the device settings menu and Acquisition tab and set the analogue output to DAC or I/E converter. The instrument is by default set to DAC. For regular measurements it is advised to use the DAC output.

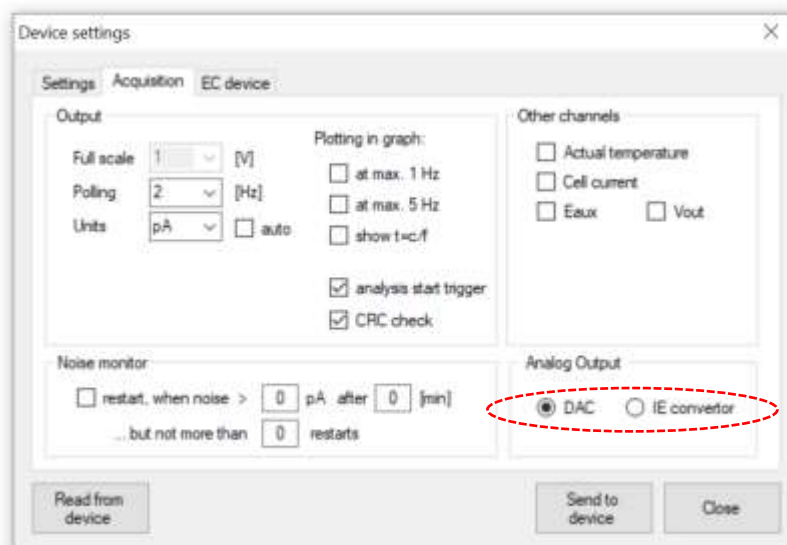

Fig. 52. Dialogue Elite Acquisition tab analog Output setting.

DAC output

The DAC output is the processed signal by the ROXY Exceed's CPU and is identical to that of the digital cell current signal obtain via data-acquisition over LAN using the Dialogue Elite software.

The signal in mV from this output is directly related to the range setting of the ROXY Exceed. So for example in the case the 200 μA measurement range is selected 'Range = 200 μA ' the DAC signal on the analog data connector corresponds with +1000 mV = +200 μA and -1000 mV = -200 μA (so +/- 1V full scale). To convert the signal in mV to the actual cell current in nA use the following calculation:

$$I_c (\text{nA}) = \frac{V_{\text{out}} (\text{mV})}{1000 \text{ mV}} \times \text{Range setting (nA)}$$

So for example a signal on the output of 250 mV in the 200 nA range corresponds with an actual cell current of $(250/1000) \times 200 \text{ nA} = 50 \text{ nA}$.

I/E output

The I/E output is the unprocessed analog signal from the I/E converter circuit. This signal is a true analog signal which is as close as practically possible to the working electrode (WE). The maximum output voltage of the I/E output is +/- 2.5V under all conditions and is independent of the potentiostat range setting. The signal in mV is related to the selectable I/E resistor of 100M, 10M, 1M, 100K or 1K in the I/E converter circuit. The actual cell current can be calculated from the analog I/E output in Volt using the following formula:

$$I_c (\text{Ampere}) = \frac{V_{\text{out}} (\text{Volt})}{R_{\text{I/E}} (\text{Ohm}) \times 2}$$

So for example an I/E output signal of 250 mV in the 5 nA range ($R_{\text{I/E}} = 100 \text{ M}\Omega$) corresponds to an actual cell current of $0.25\text{V}/(2 \times 1\text{E}8\Omega) = 1.25\text{E-}9\text{A} = 1.25 \text{ nA}$. In the table below, the I/E resistor value is listed for every range setting.

Table VI. ROXY Exceed I/E converter resistors

Current Ranges	I/E Resistor (Ω)
1nA, 2nA, 5nA, 10nA	100M
20nA, 50nA, 100nA	10M
200nA, 500nA, 1 μ A, 2 μ A, 5 μ A, 10 μ A	100K
20 μ A, 50 μ A, 100 μ A, 200 μ A, 500 μ A, 1mA	1K
2 mA, 5 mA, 10 mA	100
20mA, 50mA, 100mA	10

In the potentiostat accessory kit a dedicated Output cable, D9 male – open, 2m (pn 250.0128A) is supplied. It is advised to use this manufacturer-supplied cable for this type of measurements.

For reference, the layout of the analog data out connector is shown in the table below.

Table VII. Analog data output connector lay-out.

Pin	Layout
1	$V_{out 1}$
2	$V_{out 2}$
3	$V_{out 3}$
4	$V_{out 4}$
5	$V_{out 5}$
6 - 9	GND

To measure for example the analog signal of cell 1 with an external A/D converter:

- Connect the signal wire, lead of pin 1 ($V_{out 1}$), to the analog measurement channel of the A/D converter.
- Connect the GND wire, lead of pin 6 (or 7-9), to the corresponding analog ground connection of the A/D converter.

Digital I/O connector

The potentiostat has one 25-pins digital I/O connector which enables control of (or by) external equipment. The IO connector contains 18 TTL contacts (5 outputs and 13 inputs, 3.3V CMOS logic), 2 RELAYS (contact closure) and 1 ground (GND connection).

TTL inputs & outputs

Both the TTL inputs and outputs are default = high (3.3 Volt). The TTL inputs are level triggered: the contacts require a minimum TTL-low pulse duration of 100 ms. If multiple activations are required the next pulse should be given after 100 ms TTL high. When the input is kept low, only one activation will occur.

Relays

The ROXY Exceed has 2 free programmable contact closure outputs:

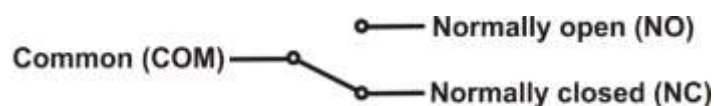

- Relay1: pin 1 normally closed, pin 2 normally open, pin 3 common.
- Relay2: pin 4 normally closed, pin 5 normally open, pin 6 common.

The maximum rating for these contact closure outputs are 24 VDC (switching voltage) and 0.25 A. The relays can be controlled in the Dialogue Elite software and Clarity Chromatography software.

AUX

The ROXY Exceed has 4 free programmable TTL outputs AUX1 – AUX4 (pin 7 – 10). These contacts are default 'high' 3.3V (inactive), when active the status is 'low' 0V.

Overload

The overload output (pin 11) can be used to monitor if the cell current goes out of range during a measurement. An 'Out of range' error appears when the cell current I_{cell} exceeds the limit of the current range at which the measurement is performed. See figure on the next page.

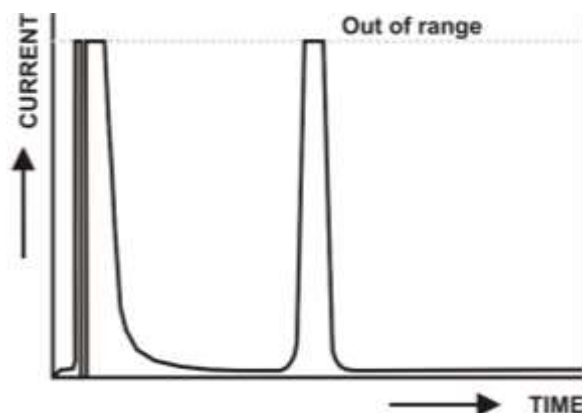

Fig. 53. Example of a current signal where the cell current exceeds the maximum current level and the signal is 'out of range'.



It is important to recognize an 'out of range' (overload) situation, because it may lead to erratic results when quantifying analyte concentrations in samples.

If for instance the cell current goes in out of range during the recording of an response of the conversion of a target compound, it can be (in most cases) easily recognized by a flat top of the peak and a very abrupt transition to the flat top at the edges.

By default the status of the overload output is 'high' 3.3V. When the cell current has the status 'out of range' the overload output will change status to 'low' 0 Volt, until the cell current returns to a value within the measurement range again. The overload output (pin 11) is one of the configurable I/O's.

<input checked="" type="checkbox"/>	P 1 1 (O V L D) = 1	<input type="checkbox"/>	P 1 8 (A Z E R O) = 1	I O
<input type="checkbox"/>	P 1 2 (C - O N) = A L L	<input type="checkbox"/>	P 2 1 (S T A R T) = A L L	
<input type="checkbox"/>	P 1 5 (C - O F F) = 2			
	P R E V			

The configurable I/O's can be programmed in the IO menu, which is a sub-menu of the CONFIG menu. By default, the overload output is assigned to cell 1: 'P11 (OVL D) = 1'. This means that only when the cell current of cell 1 is 'out of range' the status of the overload output will change to 'low' 0V. For all other cells present in the ROXY Exceed (in case of a DCC version of the instrument) an out of range situation will not trigger a response on pin 11.

The following options can be selected for the configuration of pin 11:

P11(OVLD) = 1	Overload output active for cell 1 only
P11(OVLD) = 2	Overload output active for cell 2 only
P11(OVLD) =	Overload output inactive
P11(OVLD) = All*	Overload output active for all cells present

*) When this option is selected, the overload output will be active for all reactor cells present in the ROXY Exceed. If the cell current of either one of those cells will go 'Out of range' the overload input pin 11 will become active.

Cell on, Cell off

The ROXY Exceed has 2 TTL inputs to switch on cells (pin 12 – 13) and also 2 inputs to switch off cells (pin 15 -16) AUX1 – AUX4 (pin 7 – 10). This input command can be used for example to switch on reactor cells with an analog trigger signal. Two of the inputs are configurable (pin 12, pin 15, cell on and off respectively) in the IO menu (see previous chapter about the overload output). The configuration settings of these inputs are: 1, 2, ' ', and all. In case 'all' is selected all cells present in the ROXY Exceed will be switched on or off when the corresponding input is triggered.

Autozero

The ROXY Exceed has 2 TTL inputs (pin 18 – 19) available to autozero the cell current of the cell(s). Triggering these inputs enables external activation of the auto zero command. This function is active only when the 'I-cell' is displayed. One autozero input is configurable (pin 18) in the IO menu (see previous chapter about the overload output). The configuration settings of this input are: 1, 2, ' ', and all. In case 'all' is selected the cell current of all cells present in the ROXY Exceed will be zeroed when the input is triggered.

Start

The ROXY Exceed has 2 TTL inputs (pin 21 – 22) available to start data-acquisition and/or start a scan. One start input is configurable (pin 21) in the IO menu and can be used for example to start the data-acquisition of all cells synchronously using only one trigger input when the setting 'All' is selected.



The manufacturer will not accept any liability for damage, direct or indirect, caused by connecting this instrument to devices that do not meet the relevant safety standards.

Programming outputs

In the Dialogue Elite software the ROXY Exceed outputs (Relays and AUX) can be controlled and programmed. This can be done via the Potentiostat tab on the main window and via timed event tables. By default the I/O is hidden and not shown in the monitor tab. To be able to see the status and control buttons for the I/O go to the Device settings window (settings tab) and check the 'Show status outputs' checkbox under the controls section.

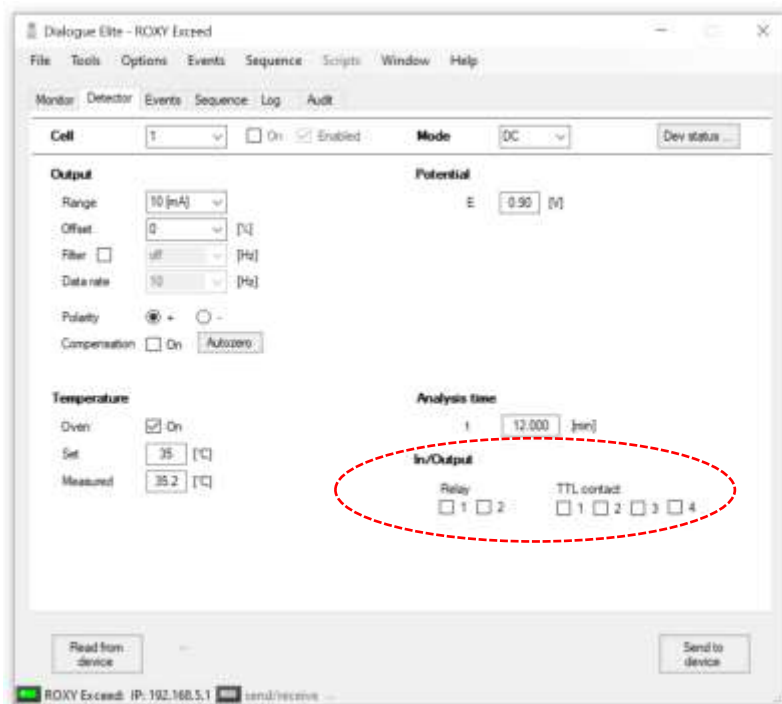

Fig. 54. Dialogue Exceed Potentiostat tab with I/O status and control buttons (check boxes).

The status of the Relays and TTL inputs can be set to active () or inactive (). The selected state of the outputs will be activated after clicking the 'Send to device button'.

The outputs can also be switched via timed events under the events tab. By opening a 'New event' under the Events pull-down menu, a new Event table/file can be created. Subsequently, the Event editor will open. Select the event 'Output A' and assign a time at which the output should be switched and select which output should be activated (Relay, Aux) under

the value field. See example below in the figure below. Make sure to program a second step to inactivate the Output again and put it back in its initial inactive state again.

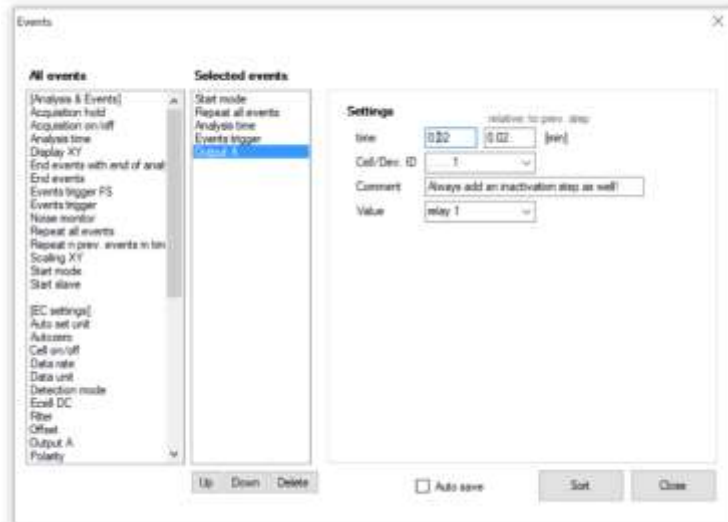

Fig. 55. Dialogue Exceed Event Editor window. Programming of output A.

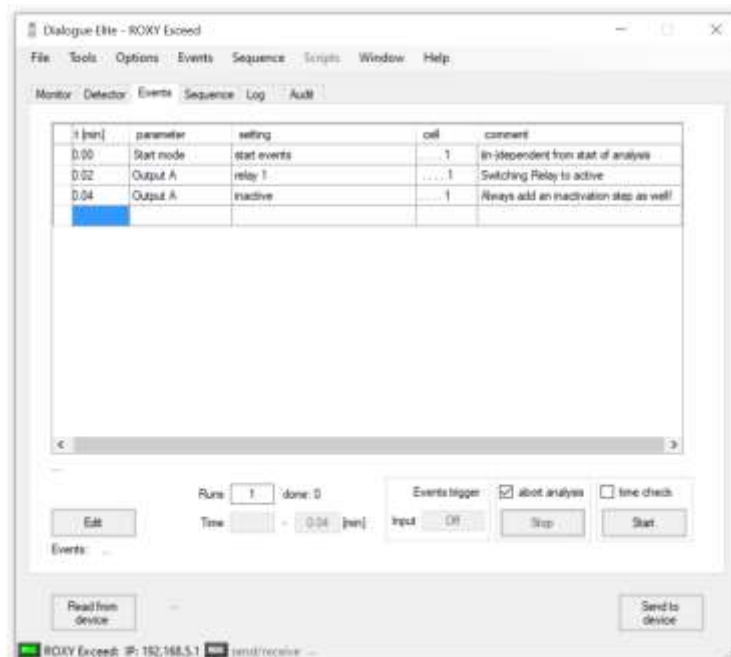

Fig. 56. Dialogue Exceed Event table window with an example of programming timed events for output A (in this case Relay 1).

Table VIII. DIGITAL I/O connector layout.

Pin	Type I/O	Function (default)	Configurable I/O	Description
1,2,3	Relay 1	Relay 1	-	Contact between 3 (common) and 1 (default), activated by time file Outp 0100 or Command 47
4,5,6	Relay 2	Relay 2	-	Contact between 6 (common) and 4 (default), activated by time file Outp 0001 or Command 47
7	TTL OUT	AUX 1	-	Free programmable TTL output, activated by time file Outp 0001, Command 47
8	TTL OUT	AUX 2	-	Free programmable TTL output, activated by time file Outp 0010, Command 47
9	TTL OUT	AUX 3	-	Free programmable TTL output, activated by Command 47
10	TTL OUT	AUX 4	-	Free programmable TTL output, activated by Command 47
11	TTL OUT	Overload	A*, 1-2	Active in case of signal overload ('OUT OF RANGE', 'PAD OVLD')
12	TTL IN	Cell on 1	A, 1-2	Trigger to switch the cell on
13	TTL IN	Cell on 2	-	Trigger to switch the cell on
15	TTL IN	Cell off 1	A, 1-2	Trigger to switch the cell off
16	TTL IN	Cell off 2	-	Trigger to switch the cell off
18	TTL IN	Autozero 1	A,1-2	Trigger to zero/null the cell current (compensation I _c)
19	TTL IN	Autozero 2	-	Trigger to zero/null the cell current (compensation I _c)
21	TTL IN	Start 1	A,1-2	Trigger to start a Scan and Data-acquisition
22	TTL IN	Start 2	-	Trigger to start a Scan and Data-acquisition
25	GND	GND	-	Ground connection

*) A = All boards.

In the potentiostat accessory kit (pn .0200) a dedicated I/O cable is supplied with an I/O connector board with screw terminal connections for easy connection of open-ended electrical wiring for I/O:

pn 250.0131B ROXY Exceed I/O conn. Board

pn 250.0131C ROXY Exceed I/O cable 25M-25M, 1.8m

For use, connect the I/O cable to the 25-pins I/O connector on the potentiostat rear panel, subsequently connect the I/O connector board to the end of the I/O cable.



On the rear side of the I/O connector board a label is adhered for reference with the lay-out of the digital I/O connector as described in Table VIII.



Fig. 57. Left: ROXY Exceed rear panel with I/O screw terminal board installed.

Chassis grounding stud

On the rear panel a chassis grounding stud is available at the lower right-side, next to the ventilation holes of the power supply compartment. This grounding stud which is connected to the central grounding point of the instrument can be used for shielding purposes. For example, to shield the flow cell from other equipment which might be coupled in series with the electrochemical potentiostat such an MS.

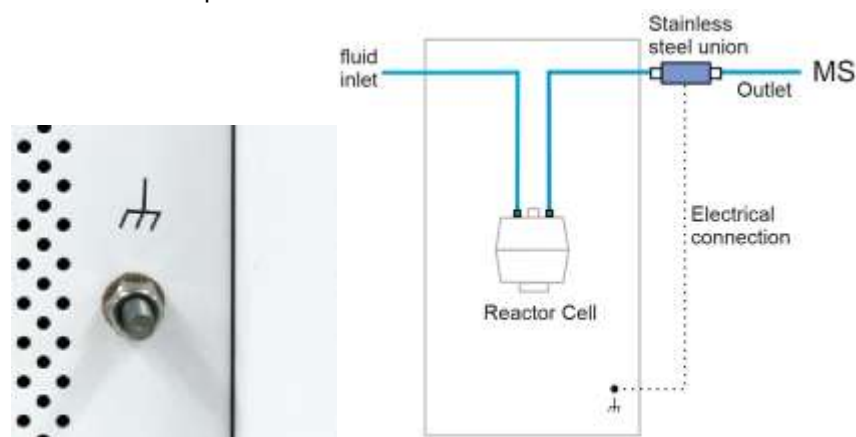

Fig. 58. Left: ROXY Exceed rear panel grounding stud. Right: example of shielding the flow cell by grounding the solvent outlet tubing. An optional grounding kit is available for this purpose (pn 250.0035).



Use the chassis grounding stud for shielding only, not for safety grounding .

CHAPTER 10

Troubleshooting

Even though great care was taken in the design of the ROXY Exceed, problems may occur during operation of the instrument. The information in this chapter may help you to identify and solve the source of the problems. In the event that the problems cannot be solved after following the instructions in this troubleshooting section, contact your local supplier for further assistance.

Instrument errors

Incidental fault conditions may occur in any instrument. The ROXY Exceed will generate an error message containing an error number with a short description for several hardware fault conditions, which will be shown in the instruments LCD display.

Table IX. Error messages.

Error	Message
11	Checksum error
12	Temperature sensor 1 error
13	Disconnect flow cell x
14	Control board SRAM error
20	Checksum error

Please contact your local supplier if one of the above errors occur for further instructions. In the case the instrument does not power up at all check the following remedies.

No potentiostat response

Possible cause	Remedy
No power	Plug in power cord
Power switch off	Turn this switch ON (at the rear panel)
Faulty fuse	Replace fuse
Divergent mains voltage	Check line voltage



Make sure the ROXY Exceed is connected to a grounded power source with a line voltage which is within the specified ratings. If the ROXY Exceed does not respond, a fuse in the mains inlet may be blown.

Furthermore the following messages can be displayed on the LCD screen or PC control software during a measurement:

Table X. Messages.

Message	Advice
01 Out of range*	Output is either above +1.0V or below -1.0V. Pressing AZERO may give an adequate read-out again. If the message remains after pressing AZERO, the autozero function is unable to compensate the background cell current. Advice: use a less sensitive range in the SETUP menu.
02 PAD overload	Charging current in pulse mode out of range. Pressing AZERO may give an adequate read-out again. If not, it is advisable to change the pulse settings (increase t1) or use a less sensitive range.

Make sure that maintenance is performed on a regular basis.

*) An 'Out of range' error appears when the cell current I_{cell} exceeds the limit of the current range at which the measurement is performed. See figure below.

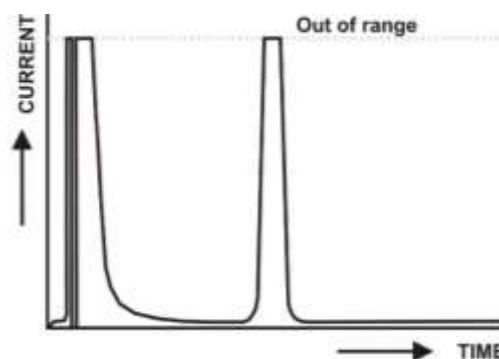

Fig. 59. Example of a current signal were the cell current exceeds the maximum current level and the signal is 'out of range'.



It is important to recognize an 'out of range' (overload) situation, because it may lead to an incorrect assessment of the current during an electrochemical reaction.

No response, no product in MS

Possible cause	Remedy
No power	Check line voltage setting, plug in power cord
Power switch off	Turn this switch ON (at the rear panel)
Faulty fuse	Replace fuse
Cell disconnected, or switched off	Check connection
WE contact problem	uPrepcell: check the spring construction in the WE contact, should be flexible. If not: replace.
Air or gas bubbles in cell	Read filling instructions, check for bubbles at the outlet
Conditioning of WE	Follow conditioning instructions
Fouled WE	Clean WE

Saturation of output (overload)

Possible cause	Remedy
Damaged REF	Check with spare REF, replace if necessary
Damaged WE	Replace cell block
Cell incorrectly connected	Check connections (REF: black, WE: red, AUX: blue)
Normal behavior	With high substrate concentrations it can be normal behavior. Check with solvent (without substrate) if current is at expected value and in scale. Increase range if possible.

Erratic cell current value or offset after current compensation

In case an Autozero, Offset or a change of range is initiated on an instable or changing current signal (baseline), this may lead to the display of an erratic current value or erratic offset in current. This is expected behavior. An Autozero, offset or change of measurement range will trigger an internal calculation procedure in the detector based on the actual cell current. This is an iterative process and the cell current is measured several times during the calculation process. In case the cell current is not stable during the calculation process this might lead to errors.



Do not execute an autozero, offset or range change when the cell current is not stable or the baseline did not stabilize.



Remedy: In the event it does happen, the issue can be simply solved by setting the Compensation to OFF (Comp = OFF) in the STAT screen or CDS control software. Subsequently, wait till the background current is stable/stabilized and execute an Autozero again.

In the case event tables are programmed in LC methods in the CDS software with an Autozero action, make sure that the autozero is programmed in a part of the chromatogram where the signal is stable. So at the beginning of the run, during the hold-up time (so before the unretained/solvent peak elutes). Or at the end of the run.

Dummy cell test

External dummy cell

A successful dummy cell test confirms that the controller, including the cell cable, functions properly. A full dummy cell test consists of a reading of the cell current, and a 15 min noise measurement.



Fig. 60. Left: cell cable with external dummy flow cell (pn 250.0040). Right: detector with external dummy flow cell.

An external dummy flow cell (pn 250.0040) is shipped with every ROXY Exceed instrument for troubleshooting purposes and maintenance checks. The dummy cell test is fully automated in Antec's Dialogue Elite software. The resulting report shows if the detector is passed or failed.

It is also possible to perform a dummy cell test by using data acquisition software. The 'current reading' can be obtained from the LCD display or

CDS software. For a full dummy cell test a 15 min noise measurement is needed as well, without injection (by-passing the AS). If the result of the current reading (I_c) and noise measurement with the dummy cell is within specs, the controller is excluded in a troubleshooting procedure.

The dummy flow cell consists of a resistor of 300 MOhm and a capacitor of 0.47 μ F in parallel. The current is measured over the resistor according to Ohm's law ($V = I * R$), hence with a working potential of 0.80 V the current will be about 2.67 nA.

Small differences are due to the tolerance of the resistor. The capacitor functions as a 'noise generator' and resembles the capacitance of a flow cell in an (U)HPLC set-up. The noise should be less than 4 pA, provided that the dummy cell is within the fully closed Faraday shielded instrument at the same position as the flow cell. The cell and cable must be positioned in such way that it is not in the air flow of an oven fan.

Table XI. Dummy cell test settings.

Parameter	Setting
Mode	DC
Cell potential	0.80 V
Oven	35 °C, door closed, stable*
Filter	Off
Range	1 nA/V
Data rate noise measurement	≤ 10 Hz
Cell and cable position	Not in full air flow of an oven fan

* It is allowed to run a dummy cell test at a lower temperature (incl oven off) or with shorter stabilization time if the instrument appears stabilized. However, in case 'failed', repeat the test under above conditions to rule out short stabilization or temperature issue.

Noise measurement

A baseline trace is obtained for 15 minutes to measure the noise. Evaluation of the noise level is done by averaging 30 peak to peak values from segments of 30 s (total of 15 min) using appropriate software.

$$\text{noise} = \frac{n_1 + n_2 + n_3 + \dots + n_{30}}{30}$$

This procedure is fully automated in Antec's Dialogue Elite software. In case no software tools are available, an estimate can be made. Provided

the baseline is stable without significant drift, two lines through the averaged maximum and minimum values are drawn. The noise is obtained by subtraction:

$$\text{noise} = I_{\max} - I_{\min}$$

However, in case 'failed' or near 4 pA value, repeat the test with 30 segments to rule out an error in the estimated value.

When a DA convertor is used for data acquisition without any conversion factor, the data unit is in (micro, milli-) Volt. With a range setting of 1 nA, which is 1 nA/V actually, the noise value is easily converted: 1 mV = 1 pA.

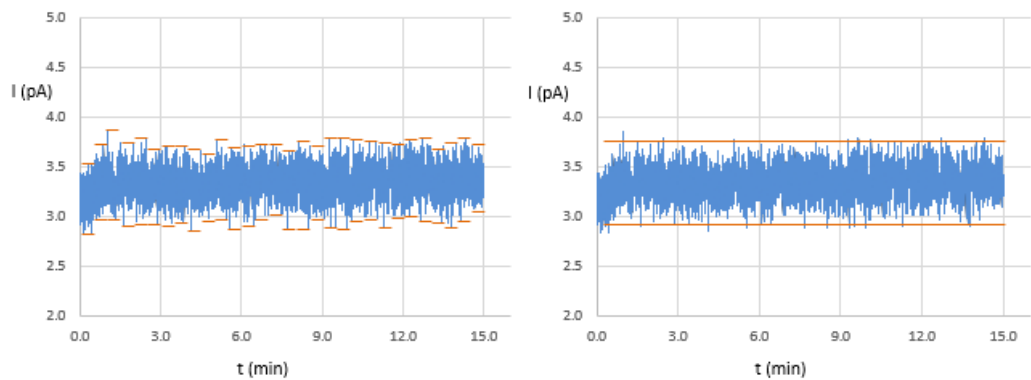

Fig. 61. Baseline noise measurement from 30 segments (left) and an estimate (right). The noise in both cases is 0.8 pA.

Steps to perform a dummy cell test

In case a CDS (Chromeleon, Clarity, OpenLab etc.) is used to perform the dummy cell test, take the following steps to obtain the I_{cell} and noise reading:

1. Switch off the cell and disconnect the flow cell from the cable.
2. Leave the flow cell in place, and connect a dummy cell as shown in the previous page(s).
3. Set measurement conditions as per above Table XI "Dummy cell test settings" and switch on the cell.
4. Wait until the cell current (baseline) stabilizes. It may take some time for the dummy cell to be at measurement temperature (about 20 min).
5. Start the measurement. When done, evaluate the **noise** on the ECD data channel. Take the **I_{cell} reading** from the direct control window in the CDS, or from the Elite display.

Test criteria

- I_{cell} = 2.67 ± 0.05 nA
- Noise < 4 pA (< 4 mV @ 1 nA range)



The results (cell current and noise) of the dummy cell test should be within the above mentioned test criteria. If the current value I_{cell} and the noise are not within the criteria it is an indication that something could be wrong with the detector hardware. Please consult your local representative.

Internal dummy cell

In case the external dummy cell fails, or no external dummy cell is available, the ECD also has the option to run an internal dummy cell test for further troubleshooting. No cell cable or dummy cell are connected, the internal dummy cell is integrated on the sensor board.

To start the test, in MAIN select DIAG, followed by NOISE. This activates a timer in the NOISE screen, and after 10 seconds of stabilization auto zero is activated and the dummy cell test 'current reading' is ready. The internal dummy cell test is a visual check. Both the cell current and noise are assessed from the LCD screen. For the noise estimation the I_c is monitored for half a minute and the min and max value written down. The difference between min and max should not exceed more than 0.004 nA (4 pA).

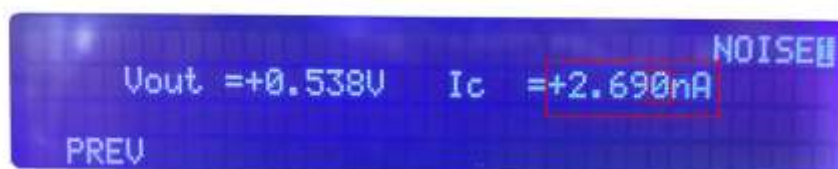

The V_{out} of 0.538V reflects the analog output signal of the ECD. In case an AD converter is used for data acquisition this value should correspond with what is acquired in the chromatogram. If applied, any conversion or multiplier factor in the CDS should be considered as well.

The range setting of the internal dummy cell test is 5 nA/V, to facilitate this Output test. At 1 nA/V the signal would run of scale completely. The visually checked noise spec at 5 nA/V range is 4 pA.

No display

The internal dummy cell test can also be performed with the Dialogue Elite software. See figure below. First, start "Options/Dummy cell noise test". When the script has started, in 'monitor' tab check () the Internal dummy cell checkbox. The cell on/off will automatically uncheck, which is correct because the external cell circuit must be off.

Evaluate the cell current in the monitor window. The internal dummy cell current and noise level should fall within the criteria specified on the previous page. Make sure to uncheck the Internal dummy cell option again from the device settings menu after the test.

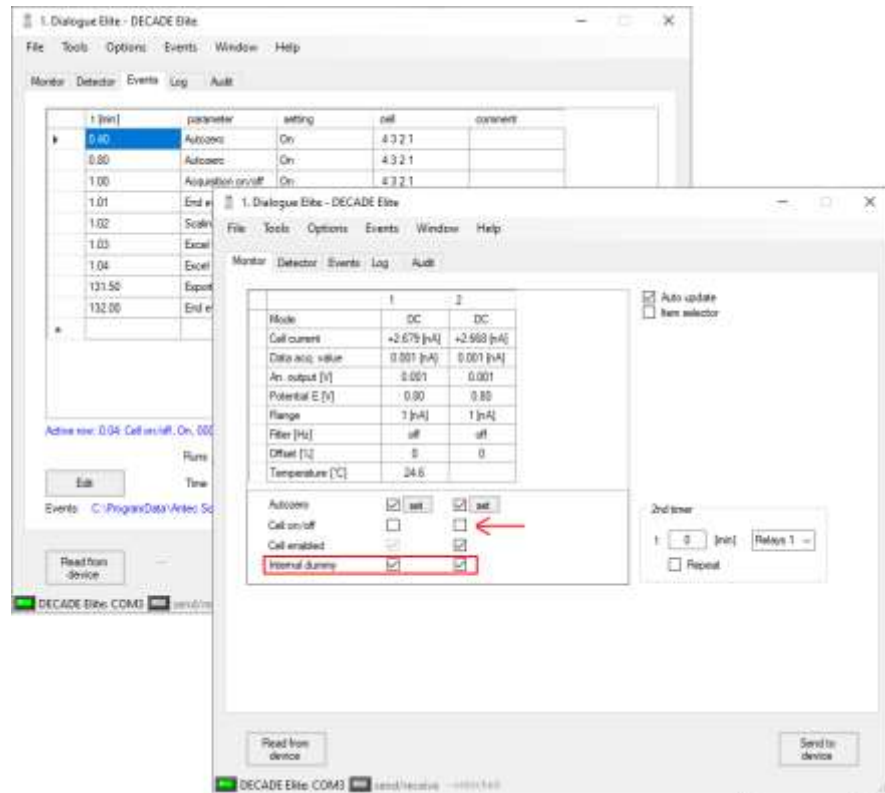

Fig. 62. After starting the "Dummy cell noise test", the internal dummy cell must be checked. Note that the (external) cell is off.

Known issues

The following issues are known (FW version 1.10.08) and work arounds are advised. In the second column (instr.) the type of instrument to which the issue applies is indicated. SCC = Single Cell control (standard product), DCC = Dual Cell control (option).

#	Instr.	Description	Work around
1	DCC	Not all pulse mode parameter (E4, E5, t4 and t5) of sensor board 1 will be updated to sensor board 2 in enslave mode (CONFIG menu).	Set these specific parameters for board 2 in the PULSE ² , SETUP3 menu
2	SCC, DCC	Maximum compensation current values (Max-Comp) shown in the SETUP menu are incorrect for the 200 nA and 500 nA range.	The maximum current which can be compensated in these ranges is 25 μ A. See table II and III in Chapter 3 for an overview of the maximum compensation for all selectable ranges in the DC and pulse mode.
3	SCC, DCC	In Pulse mode - 2 the 0.005, 0.002 and 0.001 Hz are selectable from the method window of the CDS control drivers (Dialogue Elite, Chromeleon), but must not be used. It can lead to noise and regular spikes in the chromatogram.	Select an ADF filter setting in the range of 0.5 – 0.01 Hz for the Pulse mode - 2.
4	DCC	Related to issue #3: If one of the cells is operated in Pulse mode - 2, and the other in either DC or pulse mode: do not use an ADF filter setting of 0.005, 0.002 and 0.001 Hz on both cells. These filter settings can affect the performance of the cell operated in Pulse mode - 2.	Select an ADF filter setting in the range of 0.5 – 0.01 Hz for <u>both</u> cell 1 and 2.

CHAPTER 11

Potentiostat accessories

The ROXY Exceed potentiostat is shipped together with a number of parts. The listing in Table below may not be complete, see check list of delivery for complete listing.

Table XII. Accessory kit (pn 211.0200) ROXY Exceed potentiostat

Part number	Component
250.0040	External dummy flow cell
250.0107	Column clamp 12 mm
250.0113	Fuse 2.5 AT 250 V
250.0170	LAN (UTP) cable, crossed, 3 meter
250.0175	USB cable, A-B, 3 meter
250.0131B	I/O conn. Board
250.0131C	I/O cable 25M-25M, 1.8m
250.0032X	ROXY Exceed trigger cable
250.0128A	Output cable, D9 male – open, 2m
250.0116	Mains cable (Europe)
250.0118	Mains cable (USA)
250.0126A	Cell cable

For a Vici Valco electrically-actuated 2-position valve, with an E2CA, EHCA actuator a serial cable is available for control via the ROXY Exceed potentiostat: pn 250.0190 Serial valve cable, Valco, 2m.

For these and other ROXY Exceed parts or reactor cells contact your local supplier.

Grounding kit

For the ROXY potentiostat (pn) an optional grounding kit pn 250.0035 is available.



With a ROXY EC system (pn 210.0070) or ROXY EC/LC system (pn 210.0080C) this part is provided with the systems. An ESI interface of an MS is usually operating at high voltages of typically 3 – 5 kV. In cases where the inlet of the ESI-MS is not grounded, the grounding kit (pn 250.0035) must be used. If not used it may lead to damage of the ROXY Exceed potentiostat.

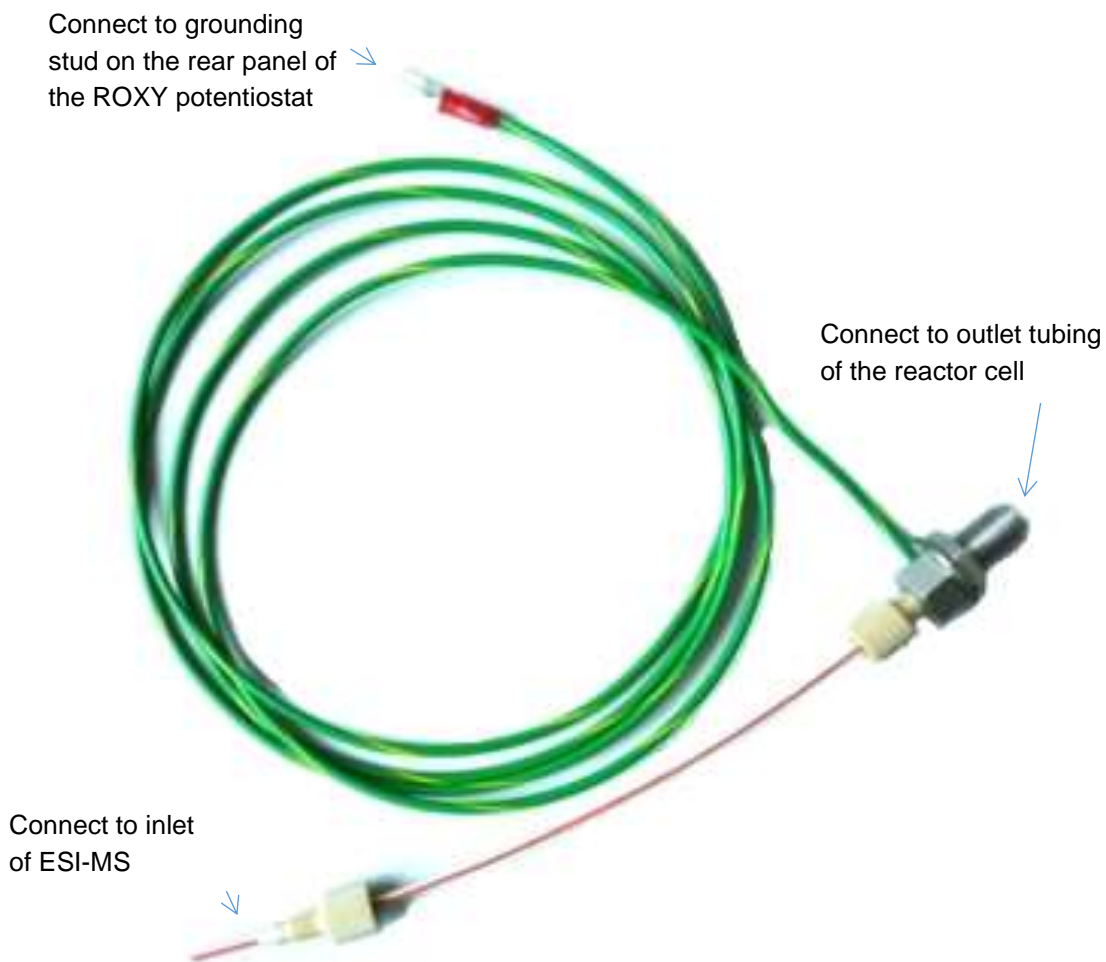

For detailed installation information please consult the relevant installation documentation of the ROXY EC or EC/LC system or contact Antec support.

Trigger cable

The ROXY potentiostat is delivered with 250.0032X ROXY potentiostat trigger cable.



The 25-pins d-sub connector of the trigger cable should be connected to the digital I/O connector on the rear panel of the ROXY Exceed potentiostat. The output lead with screw terminal block marked 'MS trigger' can be used to automatically start acquisition of an MS via the Dialogue Elite software, by connecting it to an available start input of an MS. Check the technical documentation of your specific MS for details how to make the connections on the MS. The black wire on the cable should be connected to ground.

The input lead with screw terminal block marked 'START trigger' can be used to automatically start an event table of sequence in Dialogue Elite or a sample sequence in Clarity, by connecting it to an available external start output (relay/contact closure) of for example an LC system, autosampler (inject signal) or other external device. Check the technical documentation of your specific equipment for details how to make the connections on the external device. The black wire on the cable should be connected to ground.

Index

ANALOG DATA, 100
auxiliary electrode, 53
Biological Hazard, 13
buttons DECADE Elite keyboard, 39
cleaning of detector, 36
compensation, 58
DAC output, 102
digital I/O connector, 103
Digital I/O connector, 17
Door sensor, 18
dual flow cell control, 55
dual flow cell navigation, 57
dummy cell
 external, 116
 internal, 120
E1, control, 46
E2, control, 46
Electrical safety, 11
electrochemical reaction, 70
Elite Dialogue software, 30
EN 55011 group 1 class A ISM equipment, 26
Environmental specifications, 20
filter, 46, 60
fuses
 replacement of, 12, 36
I/E converter, 53, 55
I/E output, 102
I/E relationship, 69
inject marker, trigger, 95
installation
 DECADE Elite, 19, 124
Instrument description, 16
integrator
 connection of trigger, 95
Intended use, 9
internal dummy cell test, 120
IP address, 26
ISO, 10
keyboard DECADE Elite, 39

LAN, 94
LAN connector, 17
LC tubing, 35
license dongle, 51
maintenance
 cleaning of detector, 36
maximum compensation, 58
messages, 113, 114
noise, 77
offset, 59
overload, 104
Parallel mode detection, 56
polarity, 60
potential
 optimisation, 69
range, 58
reference electrode, 53
ROHS, 10
RS232C, 126
S/N ratio, 77
Safety instructions, 11
scan mode
 example, 78
 scanning voltammogram, 72
Serial mode detection, 56
Solvents, 12
specifications DECADE Elite, 85, 93
Symbols, 7
System Operation, 11
t₁, control, 49
three-electrode configuration, 53
transport box, 24
USB, 94
valve configuration, 95
Valve connector, 17
voltage clamp, 53
voltammogram
 construction, 77
 introduction, 69
warning sign, 7
Warning Symbols, 7
Waste disposal, 13
WEEE directive, 10

working electrode, 53

Working environment & safety, 11